

DEPARTMENT OF LICENSING AND REGULATORY AFFAIRS

DIRECTOR'S OFFICE

CONSTRUCTION CODE

Filed with the secretary of state on

~~These rules take effect immediately upon filing with the secretary of state unless adopted under section 33, 44, or 45a(9) of the administrative procedures act of 1969, 1969 PA 306, MCL 24.233, 24.244, or 24.245a. Rules adopted under these sections become effective 7 days after filing with the secretary of state.~~

These rules become effective 120 days after filing with the secretary of state.

(By authority conferred on the director of the department of licensing and regulatory affairs by section 4 of the Stille-DeRossett-Hale single state construction code act, 1972 PA 230, MCL 125.1504, and Executive Reorganization Order Nos. 2003-1, 2008-4, and 2011-4, MCL 445.2011, 445.2025, and 445.2030)

R 408.30500, R 408.30501b, R 408.30505, R 408.30513, R 408.30515, R 408.30516, R 408.30518, R 408.30519, R 408.30521a, R 408.30524, R 408.30529, R 408.30530, R 408.30532, R 408.30533, R 408.30533a, R 408.30533b, R 408.30534, R 408.30535, R 408.30536, R 408.30541a, R 408.30544, and R 408.30544b of the Michigan Administrative Code are amended, R 408.30533c is added, and R 408.30501a, R 408.30506, R 408.30507, R 408.30509, R 408.30510, R 408.30510a, R 408.30521, R 408.30522a, R 408.30522b, R 408.30523, R 408.30523a, R 408.30525a, R 408.30528, R 408.30528a, R 408.30536a, R 408.30537, R 408.30537a, R 408.30537b, R 408.30537c, R 408.30537d, R 408.30538, R 408.30539a, R 408.30540, R 408.30542, R 408.30544a, R 408.30545, R 408.30545a, R 408.30547b, R 408.30547c, R 408.30547d, R 408.30547e, R 408.30547f, and R 408.30547g are rescinded, as follows:

PART 5. RESIDENTIAL CODE

R 408.30500 Applicable code.

Rule 500. The provisions of the international residential code, ~~2015~~ **2021** edition, including appendices ~~A-AA, B AB, C AC, D AD, E AE, F AF, G AG, J AJ, K AK, N AN, O AO, P AP, R AR, and S AS~~ except for Sections R104.2, R104.3, R104.5, R104.7, R104.8, R104.8.1, R105.3, R105.3.1, R105.3.2, R105.6, R105.9, R108.3, R108.4, R108.5, R108.6, R109.1, R112.2, R112.3, R112.4, R113.1 to R113.3, R113.4, R114.1 and R114.2, R313.1.1 to R313.2.1, R602.11, R602.12, N1102.3.2, tables R507.2.3, N1101.12.3(3) and ~~figure R507.2.1(2)~~, R507.2.3(1), R507.2.3(2), and R507.2.4, sections M1411.8, G2411.1.1.1 to G2411.1.1.5, G2439.7.2, P2503.9, P2709.2.3, P2904.1.1 to P2904.8.2,

P2905.1, P2905.2, figure P2904.2.4.2, table P2904.2.2, tables P2904.6.2(1) to P2904.6.2(9), P3009.1 to P3009.11.1, ~~E3902.15, E3902.16, E3902.17,~~ **E3401.2 to E4304.5** and AJ102.4, the IBC-~~2015–2021~~, IECC-~~2015–2021~~, IMC-~~2015–2021~~, IPC-~~2015–2021~~, NFPA 70-~~2014–2023~~ listed in chapter 44 govern the construction, alteration, relocation, demolition, use, and occupancy of buildings and structures, and, with the exceptions noted, the international residential code is adopted by reference in these rules. All references to the International Building Code, International Residential Code, International Energy Conservation Code, National Electrical Code, International Existing Building Code, International Mechanical Code, and International Plumbing Code mean the Michigan Building Code, Michigan Residential Code, Michigan Energy Code, Michigan Electrical Code, Michigan Rehabilitation Code for Existing Buildings, Michigan Mechanical Code, and Michigan Plumbing Code, respectively. The code is available for inspection and purchase at the Department of Licensing and Regulatory Affairs, Bureau of Construction Codes, 611 West ~~Ottawa Street St.~~, **1st First Floor Ottawa Building**, Lansing, Michigan 48933. The code may be purchased from the International Code Council, through the bureau's website at www.michigan.gov/bcc, at a cost as of the time of adoption of these rules of ~~\$118.00~~ **\$140.00 for each code book**.

R 408.30501a ~~Scope.~~ **Rescinded.**

~~Rule 501a. Section R101.2 of the code is amended to read as follows:~~

~~R101.2. Scope. The provisions of the Michigan residential code for 1- and 2-family dwellings shall apply to the construction, alteration, movement, enlargement, replacement, repair, equipment, use and occupancy, location, removal and demolition of detached 1- and 2-family dwellings and townhouses not more than 3 stories above grade plane in height with a separate means of egress and their accessory structures.~~

~~Exceptions:~~

~~1. Live/work units complying with the requirements of Section 419 of the Michigan building code may be built as 1- and 2-family dwellings or townhouses. Fire suppression required by Section 419.5 of the Michigan building code when constructed under the Michigan residential code for 1- and 2-family dwellings shall conform to Section P2904.~~

~~2. Owner-occupied bed and breakfast and board and room facilities may be constructed in accordance with sections 4b and 13c of the Stille-DeRossett-Hale single state construction code act, 1972 PA 230, MCL 125.1504b and MCL 125.1513c.~~

R 408.30501b Intent.

Rule 501b. Sections **R101.3 and 101.4** of the code ~~are~~ **is** amended to read as follows:

R101.3. Intent. The purpose of this code is to establish minimum requirements to safeguard the public safety, health, and general welfare through affordability, structural strength, means of egress facilities, stability, sanitation, light and ventilation, energy conservation, and safety to life and property from fire and other hazards attributed to the built environment, and to provide safety to fire fighters and emergency responders during emergency operations. The Stille-DeRossett-Hale single state construction code act, 1972 PA 230, MCL 125.1501 to ~~MCL 125.1531~~, takes precedence over all provisions of this code.

~~R101.4. Severability. If any section, subsection, sentence, clause, or phrase of this code is found to be invalid by a court of competent jurisdiction, such decision will not affect the validity of the remaining portions of this code.~~

R 408.30505 Work exempt from permit.

Rule 505. Section R105.2 of the code is amended to read as follows:

R105.2. Work exempt from permit. Exemption from the permit requirements of the code shall not be deemed to grant authorization for any work to be done in any manner in violation of the provisions of the code or any other laws or ordinances of this jurisdiction. Permits are not required for any of the following:

(a) Building permits shall not be required for any of the following:

(i) One-story detached, accessory structures, if the floor area does not exceed 200 square feet, ~~(18.58 m² meters squared)~~.

(ii) A fence that is not more than 7 feet, ~~(2,134 mm millimeters)~~, high.

(iii) A retaining wall that is not more than 4 feet, ~~(1,219 mm millimeters)~~, in height measured from the bottom of the footing to the top of the wall, unless supporting a surcharge.

(iv) A water tank supported directly upon grade if the capacity is not more than 5,000 gallons ~~(18,927 L liters)~~ and the ratio of height to diameter or width is not greater than 2 to 1.

(v) A sidewalk and driveway not more than 30 inches, ~~(762 mm millimeters)~~, above adjacent grade and not over any basement or story below and not part of an accessible route.

(vi) Painting, papering, tiling, carpeting, cabinets, counter tops, and similar finish work.

(vii) A prefabricated swimming pool that is less than 24 inches, ~~(610 mm millimeters)~~, deep, and not greater than 5,000 gallons, ~~(18,925 L liters)~~, and is installed entirely above ground.

(viii) Swings and other playground equipment accessory to detached 1- or 2-family dwellings.

(ix) Window awnings in group R-3 and U occupancies, supported by an exterior wall that do not project more than 54 inches, ~~(1,372 mm millimeters)~~, from the exterior wall and do not require additional support, as applicable in ~~Section~~ 101.2 and group U occupancies.

(x) Decks, porches, patios, landings, or similar structures not exceeding 200 square feet, ~~(18.58 m² meters squared)~~, in area, that are not more than 30 inches, ~~(762 mm millimeters)~~, above grade at any point as prescribed by ~~Section~~ R312.1.1, are not attached to a dwelling or its accessory structures, are not within 36 inches, ~~(914 mm millimeters)~~, of a dwelling or its accessory structures, and do not serve any ingress or egress door of the dwelling or its accessory structures.

~~(b) Electrical permits shall not be required, as in accordance with the Michigan electrical code, R 408.30801 to R 408.30880, for any of the following:~~

~~(i) Repairs and maintenance: Minor repair work, including the replacement of lamps or the connection of approved portable electrical equipment to approved permanently installed receptacles.~~

~~–(ii) Radio and television transmitting stations: The provisions of the code do not apply to electrical equipment used for radio and television transmissions, but do apply to equipment and wiring for power supply and to the installation of towers and antennas.~~

~~–(iii) Temporary testing systems: A permit is not required for the installation of any temporary system required for the testing or servicing of electrical equipment or apparatus.~~

(be) Mechanical permits shall not be required for any of the following:

(i) A portable heating or gas appliance that has inputs of less than 30,000 **BTU's** ~~BTU's~~**British thermal units, BTUs**, per hour.

(ii) Portable ventilation appliances and equipment.

(iii) A portable cooling unit.

(iv) Steam, hot water, or chilled water piping within any heating or cooling equipment or appliances regulated by this code.

~~(v) Replacement of any minor part that does not alter the approval of equipment or an appliance or make such equipment or appliance unsafe.~~ **Except for a heat exchanger, replacement of any manufacturer installed part on a listed and labeled appliance or listed and labeled equipment, if the replacement does not alter the approval of the appliance or equipment or make the appliance or equipment unsafe.**

(vi) A portable evaporative cooler.

(vii) Self-contained refrigeration systems that contain 10 pounds, ~~(4.5 kg kilograms)~~, or less of refrigerant, or that are actuated by motors of 1 horsepower, ~~(0.75kW kilowatt)~~, or less.

(viii) Portable fuel cell appliances that are not connected to a fixed piping system and are not interconnected to a power grid.

(ix) An oil burner that does not require connection to a flue, such as an oil stove and a heater equipped with a wick.

~~(x) A portable gas burner that has inputs of less than 30,000 BTU's per hour.~~

~~(xi)~~**(x)** When changing or relocating a gas meter or regulator, a permit is not required when installing gas piping which shall be limited to 10 feet, ~~(3,005 mm millimeters)~~, in length and not more than 6 fittings.

~~(xii)~~**(xi)** When installing geothermal vertical closed loops under the supervision of a mechanical contractor licensed in HVAC as long as the company meets both the following:

(A) Has obtained a certificate of registration as a well drilling contractor pursuant to part 127 of the public health code, 1978 PA 368, MCL 333.12701 to 333.12771.

(B) Has installed the geothermal vertical closed loops in accordance with the department of environment, Great Lakes, and energy's best practices regarding geothermal heat pump closed loops. ~~Exemption from the permit requirements of this code shall not be deemed to grant authorization for work to be done in violation of the provisions of this code or other laws or ordinances of this jurisdiction.~~

~~(cd)~~ Plumbing permits shall not be required for either of the following:

(i) The stopping of leaks in drains, water, soil, waste, or vent pipe. If any concealed trap, drainpipe, water, soil, waste, or vent pipe becomes defective and it becomes necessary to remove and replace the same with new material, then the work is considered as new work and a permit shall be obtained and inspection made as provided in the code.

(ii) The clearing of stoppages or the repairing of leaks in pipes, valves, or fixtures, and the removal and reinstallation of water closets, if the repairs do not involve or require the replacement or rearrangement of valves, pipes, or fixtures.

R 408.30506 Submittal documents. Rescinded.

Rule 506. Sections R106.1.4 and R802.10.1 of the code are amended and Section R106.1.4 and figure 802.10.1 are added to the code to read as follows:

~~R106.1.4. Truss design data. As an alternative to the submission of truss design drawings, figure R802.10.1, the truss design data sheet, may be provided to the building official as part of the construction documents at the time of application. Truss design drawings shall be submitted to the building official prior to truss installation as required by Section R802.10.1. R802.10.1 Truss design drawings. Truss design drawings, prepared in conformance with Section R802.10.1, shall be provided to the building official and approved prior to installation. The truss design data sheet, figure R802.10.1, may be provided to the building official at the time of permit application, as an alternative to design drawings as permitted in Section R106.1.4. Truss design drawings shall include, at a minimum, the information: specified below. Truss design drawings shall be provided with the shipment of trusses delivered to the jobsite.~~

- ~~(1) Slope or depth, span, and spacing.~~
- ~~(2) Location of all joints.~~
- ~~(3) Required bearing widths.~~
- ~~(4) Design loads as applicable.~~
 - ~~(a) Top chord live load (including snow loads).~~
 - ~~(b) Top chord dead load.~~
 - ~~(c) Bottom chord live load.~~
 - ~~(d) Bottom chord dead load.~~
 - ~~(e) Concentrated loads and their points of application.~~
 - ~~(f) Controlling wind and earthquake loads.~~
- ~~(5) Adjustments to lumber and joint connector design values for conditions of use.~~
- ~~(6) Each reaction force and direction.~~
- ~~(7) Joint connector type and description, (e.g. size, thickness, or gauge) and the dimensioned location of each joint connector except where symmetrically located relative to the joint interface.~~
- ~~(8) Lumber size, species, and grade for each member.~~
- ~~(9) Connection requirements for the following:~~
 - ~~(a) Truss to truss girder.~~
 - ~~(b) Truss ply to ply.~~
 - ~~(c) Field splices.~~
- ~~(10) Calculated deflection ratio and/or maximum description for live and total load.~~
- ~~(11) Maximum axial compression forces in the truss members to enable the building designer to design the size, connections, and anchorage of the permanent continuous lateral bracing. Forces shall be shown on the truss design drawing or on supplemental documents.~~
- ~~(12) Required permanent truss member bracing location.~~

R 408.30507 Duct termination. Rescinded.

~~Rule 507. Section M1502.3 of the code is amended to read as follows:~~

~~M1502.3. Exhaust ducts shall terminate on the outside of the building. Exhaust duct terminations shall be in accordance with the dryer manufacturer's installation instructions.~~

~~If the manufacturer's instructions do not specify a termination location, the exhaust duct shall terminate no less than 3 feet (914 mm) in any direction from openings into buildings or ventilated section in a soffit. Exhaust duct terminations shall be equipped with a backdraft damper. Screens shall not be installed at the duct termination.~~

R 408.30509 Frame and masonry inspection. Rescinded.

~~–Rule 509. Section R109.1.4 of the code is amended to read as follows:~~

~~–R109.1.4. Frame and masonry inspection. Inspection of framing construction shall be made after the roof, all framing, firestopping, draftstopping, and bracing are in place and after the plumbing, mechanical, and electrical rough inspections are approved. Masonry inspections shall be made after the completed installation of base course flashing as specified in section R703.7.5 of the code and water resistive barrier as specified in section R703.2 of the code and after the masonry construction is completed.~~

R 408.30510 Use and occupancy. Rescinded.

~~–Rule 510. Sections R110.1, R110.2, and R110.3 of the code are amended to read as follows:~~

~~–R110.1. Use and occupancy. A building or structure shall not be used or occupied, and a change in the existing occupancy classification of a building or structure or portion thereof shall not be made, until a certificate of occupancy has been issued in accordance with the act.~~

~~–R110.2. Change in use. A change in the character or use of an existing structure shall not be made, except as specified in the Michigan building code, R 408.30401 to R 408.30499.~~

~~–R110.3 Certificate issued. After the building official inspects the building or structure and finds no violations of the provisions of this code or other laws that are enforced by the department of building safety, the building official shall issue a certificate of occupancy which shall contain the following:~~

~~–(a) The building permit number.~~

~~–(b) The address of the structure.~~

~~–(c) A description of that portion of the structure for which the certificate is issued.~~

~~–(d) A statement that the described portion of the structure has been inspected for compliance with the requirements of this code.~~

~~–(e) The name of the building official.~~

~~–(f) The edition of the code under which the permit was issued.~~

~~–(g) Any special stipulations and conditions of the building permit.~~

R 408.30510a Fire classification. Rescinded.

~~–Rule 510a. Section R902.1 is amended and Sections R902.3 and R902.4 of the code are added to read as follows:~~

~~–R902.1. Roof covering materials. Roofs shall be covered with materials as set forth in Sections R904 and R905. Class A, B, or C roofing shall be installed in jurisdictions designated by law as requiring their use or where the edge of the roof is less than 3 feet~~

(914 mm) from a lot line. Classes A, B, and C roofing required by this section to be listed shall be tested in accordance with UL 790 or ASTM E 108.

—Exceptions:

- 1. Class A roof assemblies include those with coverings of brick, masonry, and exposed concrete roof deck.
- 2. Class A roof assemblies also include ferrous or copper shingles or sheets, metal sheets and shingles, clay or concrete roof tile, or slate installed on noncombustible decks.
- 3. Class A roof assemblies include minimum 16 ounces per square foot copper sheets installed over combustible decks.
- 4. Class A roof assemblies include slate installed over underlayment over combustible decks.

R 408.30513 Definitions.

Rule 513. The definitions of attic and sunroom addition in Ssection R202 of the code are amended to read as follows:

R202. Definitions.

(a) “Attic, uninhabitable with limited storage” means uninhabitable attics with limited storage where the minimum clear height between joists and rafters is 42 inches, (1,063 ~~mm~~ **millimeters**), or greater or where there are not 2 or more adjacent trusses with web configurations capable of accommodating an assumed rectangle 42 inches, (1,063 ~~mm~~ **millimeters**), high by 24 inches, (610 ~~mm~~ **millimeters**), in width, or greater, within the plane of the trusses.

(b) “Attic, uninhabitable without storage” means uninhabitable attics without storage where the maximum clear height between joists and rafters is less than 42 inches, (1,063 ~~mm~~ **millimeters**), or where there are not 2 or more adjacent trusses with web configurations capable of accommodating an assumed rectangle 42 inches, (1,063 ~~mm~~ **millimeters**), high by 24 inches, (610 ~~mm~~ **millimeters**), in width, or greater, within the plane of the trusses. ~~Building Inspector” means the individual who is responsible for the administration and enforcement of the construction of buildings, structures, or appurtenances under the state construction code specified in R 408.30499 and who is registered in compliance with 2016 PA 407, MCL 339.5101 to 339.6133.~~

(c) “Building ~~Official~~” means the person who is appointed and employed by a governmental subdivision, who is charged with the administration and enforcement of the state codes specified in R 408.30499, and who is registered in compliance with 2016 PA 407, MCL 339.5101 to 339.6133.

(d) “Registered design professional” means an individual who is licensed under the occupational code, 1980 PA 299, MCL 339.101 to 339.2919**2677**.

(e) ~~“Registered inspector” means an individual who is licensed under the occupational code, 1980 PA 299, MCL 339.101 to 339.2919.~~ “Sunroom addition” means a new structure with glazing in excess of 40% of the gross area of the structure's exterior walls and roof added to an existing dwelling.

R 408.30515 Ground snow loads.

Rule 515. Figure R301.2(5) and ~~T~~table R301.2(1) of the code are amended and ~~T~~table R301.2(5) is added to the code to read as follows:

FIGURE R301.2(5)
Ground Snow Load P_g for Michigan (lb/ft²)

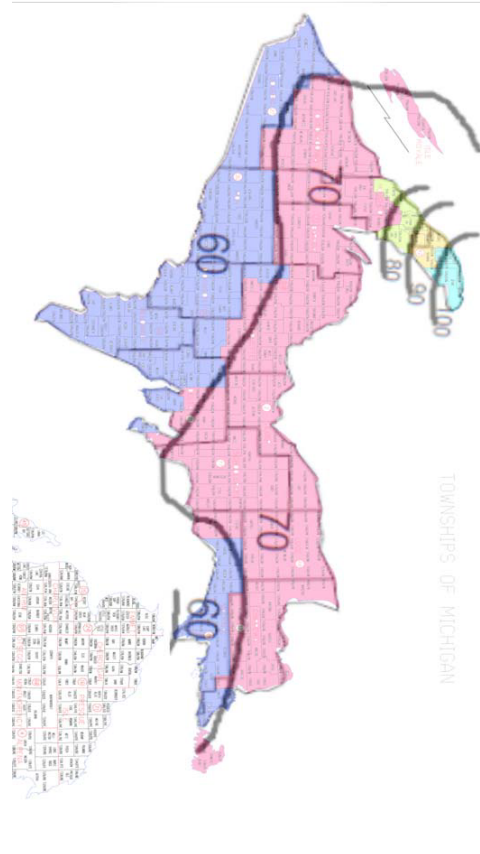

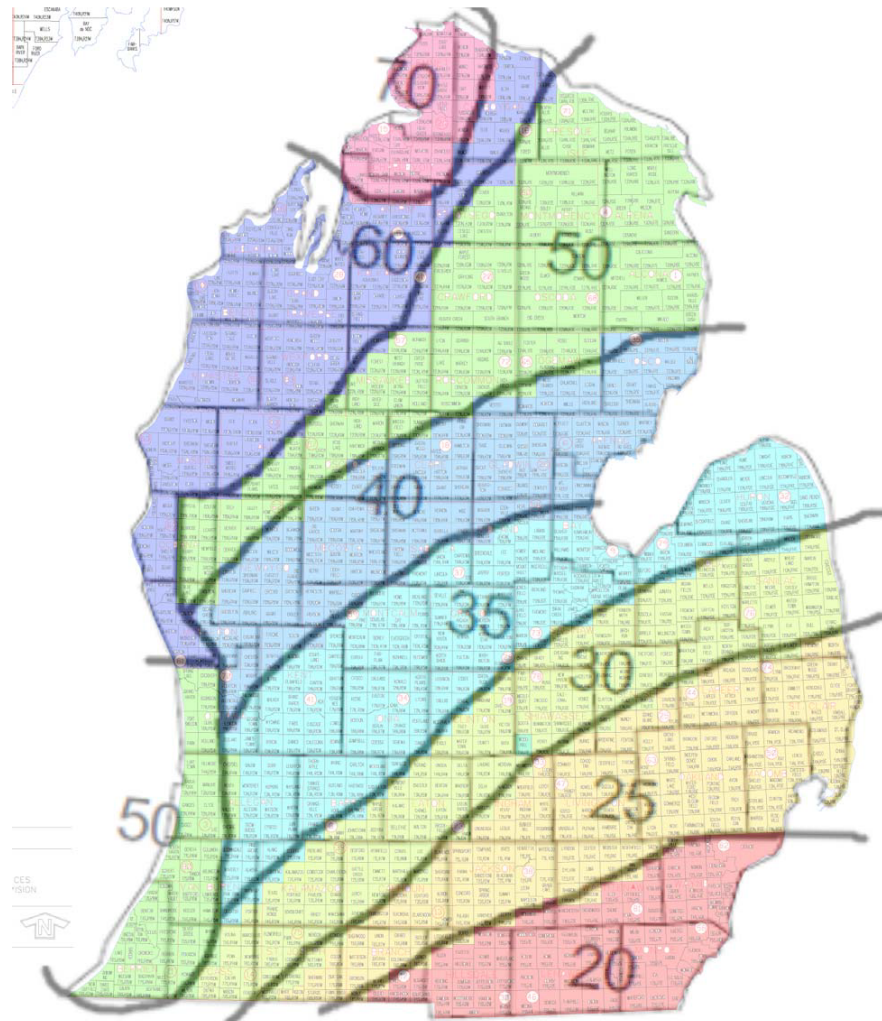

Table R301.2(5)P
Michigan Ground Snow Loads by Jurisdiction

County	Ground Snow	Jurisdictions
ALCONA	50	All
ALGER	70	All
ALLEGAN	50	All except:
	35	CITY OF ALLEGAN CITY OF OTSEGO CITY OF PLAINWELL CITY OF WAYLAND VILLAGE OF HOPKINS VILLAGE OF MARTIN TOWNSHIP OF ALLEGAN TOWNSHIP OF DORR TOWNSHIP OF GUN PLAIN TOWNSHIP OF HOPKINS TOWNSHIP OF LEIGHTON TOWNSHIP OF MARTIN TOWNSHIP OF MONTEREY TOWNSHIP OF OTSEGO TOWNSHIP OF SALEM TOWNSHIP OF TROWBRIDGE TOWNSHIP OF WATSON TOWNSHIP OF WAYLAND
ALPENA	50	All
ANTRIM	60	All except

	70	TOWNSHIP OF BANKS TOWNSHIP OF CENTRAL LAKE TOWNSHIP OF ECHO TOWNSHIP OF JORDAN TOWNSHIP OF WARNER
ARENAC	40	All
BARAGA	70	All
BARRY	35	All except:
	30	VILLAGE OF NASHVILLE TOWNSHIP OF ASSYRIA TOWNSHIP OF BARRY TOWNSHIP OF JOHNSTOWN TOWNSHIP OF MAPLE GROVE

BAY	35	All except:
	40	CITY OF PINCONNING TOWNSHIP OF FRASER TOWNSHIP OF GARFIELD TOWNSHIP OF GIBSON TOWNSHIP OF MT. FOREST TOWNSHIP OF PINCONNING
BENZIE	60	All
BERRIEN	50	All
BRANCH	25	All except:
	20	TOWNSHIP OF ALGANSEE TOWNSHIP OF CALIFORNIA TOWNSHIP OF GILEAD TOWNSHIP OF KINDERHOOK TOWNSHIP OF OVID
CALHOUN	25	All except:

	30	<p>CITY OF BATTLE CREEK CITY OF MARSHALL CITY OF SPRINGFIELD VILLAGE OF ATHENS TOWNSHIP OF ATHENS TOWNSHIP OF BATTLE CREEK TOWNSHIP OF BEDFORD TOWNSHIP OF CONVIS TOWNSHIP OF EMMET TOWNSHIP OF LEE TOWNSHIP OF LEROY TOWNSHIP OF MARENGO TOWNSHIP OF MARSHALL TOWNSHIP OF NEWTON TOWNSHIP OF PENNFIELD</p>
CASS	30	All except:
	50	<p>CITY OF DOWAGIAC VILLAGE OF CASSOPOLIS</p>

		VILLAGE OF EDWARDSBURG TOWNSHIP OF HOWARD TOWNSHIP OF LA GRANGE TOWNSHIP OF MILTON TOWNSHIP OF POKAGON TOWNSHIP OF _____ SILVER CREEK TOWNSHIP OF WAYNE
CHARLEVOIX	70	All
CHEBOYGAN	70	All except:
	60	CITY OF CHEBOYGAN VILLAGE OF AFTON VILLAGE OF WOLVERINE TOWNSHIP OF ALOHA TOWNSHIP OF BENTON TOWNSHIP OF ELLIS TOWNSHIP OF GRANT TOWNSHIP OF KOEHLER TOWNSHIP OF NUNDA TOWNSHIP OF WALKER TOWNSHIP OF WAVERLY TOWNSHIP OF WILMOT
	50	TOWNSHIP OF FOREST
CHIPPEWA	70	All except:
	60	VILLAGE OF DE TOUR TOWNSHIP OF DETOUR TOWNSHIP OF RABER

CLARE	40	All except:
	50	TOWNSHIP OF SUMMERFIELD TOWNSHIP OF WINTERFIELD
CLINTON	30	All except:
	35	CITY OF ST. JOHNS VILLAGE OF FOWLER VILLAGE OF MAPLE RAPIDS VILLAGE OF WESTPHALIA TOWNSHIP OF BENGAL TOWNSHIP OF DALLAS TOWNSHIP OF ESSEX TOWNSHIP OF GREENBUSH TOWNSHIP OF LEBANON TOWNSHIP OF WESTPHALIA
CRAWFORD	50	All
DELTA	60	All except:
	70	TOWNSHIP OF GARDEN TOWNSHIP OF MASONVILLE TOWNSHIP OF NAHMA
DICKINSON	60	All
EATON	30	All except:
	35	VILLAGE OF MULLIKEN VILLAGE OF SUNFIELD TOWNSHIP OF SUNFIELD
EMMET	70	All

GENESEE	30	All except:
	25	CITY OF DAVISON CITY OF FENTON CITY OF GRAND BLANC CITY OF LINDEN VILLAGE OF GAINES VILLAGE OF GOODRICH TOWNSHIP OF ARGENTINE TOWNSHIP OF ATLAS TOWNSHIP OF DAVISON TOWNSHIP OF FENTON TOWNSHIP OF GRAND
GLADWIN	40	All
GOGEBIC	60	All
GRAND	60	All
GRATIOT	35	All
HILLSDALE	20	All except:
	25	CITY OF LITCHFIELD TOWNSHIP OF LITCHFIELD TOWNSHIP OF SCIPIO
HOUGHTON	80	All except:
	70	TOWNSHIP OF ADAMS TOWNSHIP OF CHASELL TOWNSHIP OF DUNCAN TOWNSHIP OF ELM RIVER TOWNSHIP OF LAIRD TOWNSHIP OF PORTAGE

HILLSDALE	20	All except:
	90	VILLAGE OF CALUMET VILLAGE OF COPPER CITY VILLAGE OF — LAKE LINDEN VILLAGE OF LAURIUM TOWNSHIP OF CALUMET TOWNSHIP OF SCHOOLCRAFT
HURON	35	All
INGHAM	25	All except:
	30	CITY OF EAST LANSING CITY OF LANSING CITY OF MASON TOWNSHIP OF ALAIEDON TOWNSHIP OF AURELIUS TOWNSHIP OF DELHI TOWNSHIP OF LANSING TOWNSHIP OF MERIDIAN TOWNSHIP OF WILLIAMSTOWN
IONIA	35	All
IOSCO	40	All
IRON	60	All
ISABELLA	40	All except:
	35	VILLAGE OF SHEPHERD TOWNSHIP OF CHIPPEWA TOWNSHIP OF COE

		TOWNSHIP OF FREMONT TOWNSHIP OF LINCOLN TOWNSHIP OF UNION
JACKSON	25	All except:
	20	VILLAGE OF BROOKLYN TOWNSHIP OF COLUMBIA TOWNSHIP OF NORVELL
KALAMAZOO	30	All except:
	35	CITY OF PARCHMENT TOWNSHIP OF ALAMO TOWNSHIP OF COOPER TOWNSHIP OF OSHTEMO
KALKASKA	60	All
KENT	35	All except:
	40	CITY OF CEDAR SPRINGS VILLAGE OF CASNOVIA VILLAGE OF KENT CITY VILLAGE OF SAND LAKE VILLAGE OF SPARTA TOWNSHIP OF NELSON TOWNSHIP OF SOLON TOWNSHIP OF SPARTA TOWNSHIP OF TYRONE
KEWEENAW	90	All except:
	100	TOWNSHIP OF EAGLE HARBOR TOWNSHIP OF GRANT TOWNSHIP OF HOUGHTON
LAKE	60	All except:

	50	<p>TOWNSHIP OF CHASE TOWNSHIP OF CHERRY VALLEY TOWNSHIP OF ELLSWORTH TOWNSHIP OF PINORA TOWNSHIP OF PLEASANT PLAINS TOWNSHIP OF YATES</p>
LAPEER	25	All except:
	30	<p>VILLAGE OF CLIFFORD VILLAGE OF COLUMBIAVILLE VILLAGE OF NORTH BRANCH VILLAGE OF OTTER LAKE TOWNSHIP OF BURLINGTON TOWNSHIP OF BURNSIDE TOWNSHIP OF DEERFIELD TOWNSHIP OF MARATHON TOWNSHIP OF NORTH BRANCH TOWNSHIP OF OREGON TOWNSHIP OF RICH</p>

LEELANAU	60	All
LENAWEE	20	All
LIVINGSTON	25	All
LUCE	70	All
MACKINAC	60	All except:
	70	TOWNSHIP OF NEWTON TOWNSHIP OF
MACOMB	25	All
MANISTEE	60	All
MARQUETTE	70	All except:
	60	TOWNSHIP OF EWING TOWNSHIP OF WELLS TOWNSHIP OF REPUBLIC
MASON	60	All
MECOSTA	40	All
MENOMINEE	60	All
MIDLAND	35	All except:
	40	CITY OF COLEMAN VILLAGE OF SANFORD TOWNSHIP OF EDENVILLE TOWNSHIP OF GENEVA TOWNSHIP OF HOPE TOWNSHIP OF MILLS TOWNSHIP OF WARREN
MISSAUKEE	50	All except:
	60	TOWNSHIP OF BLOOMFIELD TOWNSHIP OF CALDWELL TOWNSHIP OF PIONEER

MONROE	20	All
MONTCALM	35	All except:
	40	VILLAGE OF HOWARD CITY VILLAGE OF LAKEVIEW VILLAGE OF PIERSON TOWNSHIP OF CATO TOWNSHIP OF MAPLE VALLEY TOWNSHIP OF PIERSON TOWNSHIP OF REYNOLDS TOWNSHIP OF WINFIELD
MONTMORENCY	50	All
MUSKEGON	40	All except
	50	TOWNSHIP OF HOLTON TOWNSHIP OF BLUE LAKE
	60	CITY OF MONTAGUE CITY OF MUSKEGON CITY OF MUSKEGON HEIGHTS CITY OF NORTH MUSKEGON CITY OF NORTON SHORES CITY OF ROOSEVELT PARK CITY OF WHITEHALL TOWNSHIP OF DALTON TOWNSHIP OF FRUITLAND TOWNSHIP OF FRUITPORT TOWNSHIP OF LAKETON TOWNSHIP OF MONTAGUE TOWNSHIP OF MUSKEGON TOWNSHIP OF SULLIVAN TOWNSHIP OF WHITEHALL TOWNSHIP OF WHITE RIVER VILLAGE OF FRUITPORT VILLAGE OF LAKEWOOD CLUB
NEWAYGO	40	All except:

	50	VILLAGE OF HESPERIA TOWNSHIP OF BARTON TOWNSHIP OF BEAVER TOWNSHIP OF DENVER TOWNSHIP OF HOME TOWNSHIP OF LILLEY TOWNSHIP OF MERRILL TOWNSHIP OF TROY
OAKLAND	25	All
OCEANA	60	All except
	50	VILLAGE OF HESPERIA VILLAGE OF WALKERVILLE TOWNSHIP OF COLFAX TOWNSHIP OF CRYSTAL TOWNSHIP OF ELBRIDGE TOWNSHIP OF FERRY TOWNSHIP OF GREENWOOD TOWNSHIP OF LEAVITT TOWNSHIP OF NEWFIELD TOWNSHIP OF OTTO

OGEMAW	40	All except
	50	CITY OF ROSE CITY TOWNSHIP OF CUMMINGS TOWNSHIP OF FOSTER TOWNSHIP OF GOODAR TOWNSHIP OF HILL TOWNSHIP OF KLACKING TOWNSHIP OF OGEMAW TOWNSHIP OF ROSE
ONTONAGON	70	All except:
	60	TOWNSHIP OF HAIGHT TOWNSHIP OF INTERIOR TOWNSHIP OF MCMILLAN
OSCEOLA	50	All except:
	40	CITY OF EVART VILLAGE OF HERSEY TOWNSHIP OF EVART TOWNSHIP OF HERSEY TOWNSHIP OF ORIENT TOWNSHIP OF OSCEOLA TOWNSHIP OF SYLVAN
OSCODA	50	All
OTSEGO	50	All except:
	60	VILLAGE OF ELMIRA VILLAGE OF VANDERBILT TOWNSHIP OF CORWITH TOWNSHIP OF ELMIRA TOWNSHIP OF HAYES TOWNSHIP OF LIVINGSTON

OTTAWA	50	All except:
	35	TOWNSHIP OF GEORGETOWN TOWNSHIP OF JAMESTOWN TOWNSHIP OF TALLMADGE TOWNSHIP OF ZEELAND
	40	CITY OF COOPERSVILLE TOWNSHIP OF ALLENDALE TOWNSHIP OF BLENDON TOWNSHIP OF CHESTER TOWNSHIP OF POLKTON TOWNSHIP OF WRIGHT
PRESQUE ISLE	50	All except
	60	TOWNSHIP OF BEARINGER
ROSCOMMON	50	All except
	40	TOWNSHIP OF NESTER
SAGINAW	35	All except:

	30	<p> CITY OF FRANKENMUTH VILLAGE OF BIRCH RUN VILLAGE OF CHESANING VILLAGE OF OAKLEY TOWNSHIP OF ALBEE TOWNSHIP OF BIRCH RUN TOWNSHIP OF BRADY TOWNSHIP OF BRIDGEPORT TOWNSHIP OF CHAPIN TOWNSHIP OF CHESANING TOWNSHIP OF FRANKENMUTH TOWNSHIP OF MAPLE GROVE TOWNSHIP OF ST.CHARLES </p>
--	----	---

		TOWNSHIP OF TAYMOUTH
SANILAC	30	All except:
	25	VILLAGE OF MELVIN TOWNSHIP OF FREMONT TOWNSHIP OF WORTH
	35	VILLAGE OF MINDEN CITY TOWNSHIP OF AUSTIN TOWNSHIP OF GREENLEAF TOWNSHIP OF MINDEN
SCHOOLCRAFT	70	All
SHIAWASSEE	30	All except:
	25	VILLAGE OF BYRON TOWNSHIP OF BURNS
ST. CLAIR	25	All
ST. JOSEPH	30	All except:
	25	CITY OF STURGIS VILLAGE OF BURR OAK VILLAGE OF COLON VILLAGE OF WHITE PIGEON TOWNSHIP OF BURR OAK TOWNSHIP OF COLON TOWNSHIP OF FAWN RIVER TOWNSHIP OF SHERMAN TOWNSHIP OF STURGIS TOWNSHIP OF WHITE PIGEON
TUSCOLA	30	All except:

	35	<p>VILLAGE OF CARO VILLAGE OF CASS CITY VILLAGE OF FAIRGROVE VILLAGE OF GAGETOWN VILLAGE OF REESE VILLAGE OF UNIONVILLE TOWNSHIP OF AKRON TOWNSHIP OF ALMER TOWNSHIP OF COLUMBIA TOWNSHIP OF ELKLAND TOWNSHIP OF ELMWOOD TOWNSHIP OF FAIRGROVE TOWNSHIP OF GILFORD TOWNSHIP OF WISNER</p>
VAN BUREN	50	All except:
	30	TOWNSHIP OF PORTER
	35	<p>CITY OF GOBLES VILLAGE OF DECATUR VILLAGE OF LAWTON VILLAGE OF MATTAWAN VILLAGE OF PAW PAW TOWNSHIP OF ALMENA TOWNSHIP OF ANTWERP TOWNSHIP OF BLOOMINGDALE TOWNSHIP OF DECATUR TOWNSHIP OF PAW PAW TOWNSHIP OF PINE GROVE TOWNSHIP OF WAVERLY</p>

WASHTENAW	25 20	All except: CITY OF ANN ARBOR CITY OF SALINE CITY OF YPSILANTI VILLAGE OF MANCHESTER TOWNSHIP OF AUGUSTA TOWNSHIP OF BRIDGEWATER TOWNSHIP OF LODI TOWNSHIP OF MANCHESTER TOWNSHIP OF PITTSFIELD TOWNSHIP OF SALINE TOWNSHIP OF SUPERIOR TOWNSHIP OF YORK TOWNSHIP OF YPSILANTI
WAYNE	20	All except
	25	Northville
WEXFORD	60	All except
	50	TOWNSHIP OF CLAM

County	Ground Snow	Jurisdictions
Alcona	50	All
Alger	70	All
Allegan	50	All except:
	35	city of Allegan city of Otsego city of Plainwell city of Wayland village of Hopkins village of Martin township of Allegan township of Dorr township of Gun Plain township of Hopkins township of Leighton township of Martin township of Monterey township of Otsego township of Salem township of Trowbridge township of Watson township of Wayland

Alpena	50	All
Antrim	60	All except:
	70	township of Banks township of Central Lake township of Echo township of Jordan township of Warner
Arenac	40	All
Baraga	70	All
Barry	35	All except:
	30	village of Nashville township of Assyria township of Barry township of Johnstown township of Maple Grove
Bay	35	All except:
	40	city of Pinconning township of Fraser township of Garfield township of Gibson township of Mt. Forest township of Pinconning
Benzie	60	All
Berrien	50	All
Branch	25	All except:
	20	township of Algansee township of California township of Gilead township of Kinderhook township of Ovid
Calhoun	25	All except:

	30	city of Battle Creek city of Marshall city of Springfield village of Athens township of Athens township of Battle Creek township of Bedford township of Convis township of Emmet township of Lee township of Leroy township of Marengo township of Marshall township of Newton township of Pennfield
Cass	30	All except:
	50	city of Dowagiac village of Cassopolis
		village of Edwardsburg township of Howard township of La Grange township of Milton township of Pokagon township of Silver Creek township of Wayne
Charlevoix	70	All
Cheboygan	70	All except:
	60	city of Cheboygan village of Afton village of Wolverine township of Aloha township of Benton township of Ellis township of Grant township of Koehler township of Nunda township of Walker township of Waverly township of Wilmot
	50	township of Forest
Chippewa	70	All except:

	60	village of DeTour township of DeTour township of Raber
Clare	40	All except:
	50	township of Summerfield township of Winterfield
Clinton	30	All except:
	35	city of St. Johns village of Fowler village of Maple Rapids village of Westphalia township of Bengal township of Dallas township of Essex township of Greenbush township of Lebanon township of Westphalia
Crawford	50	All
Delta	60	All except:
	70	township of Garden township of Masonville township of Nahma
Dickinson	60	All
Eaton	30	All except:
	35	village of Mulliken village of Sunfield township of Sunfield
Emmet	70	All
Genesee	30	All except:
	25	city of Davison city of Fenton city of Grand Blanc city of Linden village of Gaines village of Goodrich township of Argentine township of Atlas township of Davison township of Fenton township of Grand Blanc township of Mundy
Gladwin	40	All
Gogebic	60	All
Grand Traverse	60	All
Gratiot	35	All
Hillsdale	20	All except:

	25	city of Litchfield township of Litchfield township of Scipio
Houghton	80	All except:
	70	township of Adams township of Chassell township of Duncan township of Elm River township of Laird township of Portage
	90	village of Calumet village of Copper City village of Lake Linden village of Laurium township of Calumet township of Schoolcraft
Huron	35	All
Ingham	25	All except:
	30	city of East Lansing city of Lansing city of Mason township of Alaiedon township of Aurelius township of Delhi township of Lansing township of Meridian township of Williamston
Ionia	35	All
Iosco	40	All
Iron	60	All
Isabella	40	All except:
	35	village of Shepherd township of Chippewa township of Coe
		township of Fremont township of Lincoln township of Union
Jackson	25	All except:
	20	village of Brooklyn township of Columbia township of Norvell
Kalamazoo	30	All except:
	35	city of Parchment township of Alamo township of Cooper township of Oshtemo

Kalkaska	60	All
Kent	35	All except:
	40	city of Cedar Springs village of Casnovia village of Kent City village of Sand Lake village of Sparta township of Nelson township of Solon township of Sparta township of Tyrone
Keweenaw	90	All except:
	100	township of Eagle Harbor township of Grant township of Houghton
Lake	60	All except:
	50	township of Chase township of Cherry Valley township of Ellsworth township of Pinora township of Pleasant Plains township of Yates
Lapeer	25	All except:
	30	village of Clifford village of Columbiaville village of North Branch village of Otter Lake township of Burlington township of Burnside township of Deerfield township of Marathon township of North Branch township of Oregon township of Rich
Leelanau	60	All
Lenawee	20	All
Livingston	25	All
Luce	70	All
Mackinac	60	All except:
	70	township of Newton township of Portage
Macomb	25	All
Manistee	60	All
Marquette	70	All except:
	60	township of Ewing township of Wells township of Republic

Mason	60	All
Mecosta	40	All
Menominee	60	All
Midland	35	All except:
	40	city of Coleman village of Sanford township of Edenville township of Geneva township of Hope township of Mills township of Warren
Missaukee	50	All except:
	60	township of Bloomfield township of Caldwell township of Pioneer
Monroe	20	All
Montcalm	35	All except:
	40	village of Howard City village of Lakeview village of Pierson township of Cato township of Maple Valley township of Pierson township of Reynolds township of Winfield
Montmorency	50	All
Muskegon	40	All except:
	50	township of Holton township of Blue Lake

	60	city of Montague city of Muskegon city of Muskegon Heights city of North Muskegon city of Norton Shores city of Roosevelt Park city of Whitehall township of Dalton township of Fruitland township of Fruitport township of Laketon township of Montague township of Muskegon township of Sullivan township of Whitehall township of White River village of Fruitport village of Lakewood Club
Newaygo	40	All except:
	50	village of Hesperia township of Barton township of Beaver township of Denver township of Home township of Lilley township of Merrill township of Troy
Oakland	25	All
Oceana	60	All except:
	50	village of Hesperia village of Walkersville township of Colfax township of Crystal township of Elbridge township of Ferry township of Greenwood township of Leavitt township of Newfield township of Otto
Ogemaw	40	All except:

	50	city of Rose City township of Cummings township of Foster township of Goodar township of Hill township of Klacking township of Ogemaw township of Rose
Ontonagon	70	All except:
	60	township of Haight township of Interior township of McMillan
Osceola	50	All except:
	40	city of Evert village of Hersey township of Evert township of Hersey township of Orient township of Osceola township of Sylvan
Oscoda	50	All
Otsego	50	All except:
	60	village of Elmira village of Vanderbilt township of Corwith township of Elmira township of Hayes township of Livingston
Ottawa	50	All except:
	35	township of Georgetown township of Jamestown township of Tallmadge township of Zeeland
	40	city of Coopersville township of Allendale township of Blendon township of Chester township of Polkton township of Wright
Presque Isle	50	All except:
	60	township of Bearinger
Roscommon	50	All except:
	40	township of Nester
Saginaw	35	All except:

	30	city of Frankenmuth village of Birch Run village of Chesaning village of Oakley township of Albee township of Birch Run township of Brady township of Bridgeport township of Chapin township of Chesaning township of Frankenmuth township of Maple Grove township of St. Charles
		township of Taymouth
Sanilac	30	All except:
	25	village of Melvin township of Fremont township of Worth
	35	village of Minden City township of Austin township of Greenleaf township of Minden
Schoolcraft	70	All
Shiawassee	30	All except:
	25	village of Byron township of Burns
St. Clair	25	All
St. Joseph	30	All except:
	25	city of Sturgis village of Burr Oak village of Colon village of White Pigeon township of Burr Oak township of colon township of Fawn River township of Sherman township of Sturgis township of White Pigeon
Tuscola	30	All except:

	35	village of Caro village of Cass City village of Fairgrove village of Gagetown village of Reese village of Unionville township of Akron township of Almer township of Columbia township of Elkland township of Elmwood township of Fairgrove township of Gilford township of Wisner
Van Buren	50	All except:
	30	township of Porter
	35	city of Gobles village of Decatur village of Lawton village of Mattawan village of Paw Paw township of Almena township of Antwerp township of Bloomingdale township of Decatur township of Paw Paw township of Pine Grove township of Waverly
Washtenaw	25	All except:
	20	city of Ann Arbor city of Saline city of Ypsilanti village of Manchester township of Augusta township of Bridgewater township of Lodi township of Manchester township of Pittsfield township of Saline township of Superior township of York township of Ypsilanti
Wayne	20	All except:
	25	city of Northville
Wexford	60	All except:
	50	township of Clam Lake

R 408.30516 Design criteria.

Rule 516. Table R301.2(1) of the code is amended and figures R301.2(7) and R301.2(8) are added to the code to read as follows:

TABLE R 301.2(1)
CLIMATIC AND GEOGRAPHIC DESIGN CRITERIA

Ground Snow Load	Wind Speed ^d (mph)	Seismic Design Category ^f	Subject to Damage From			Winter Design Temp ^e	Ice Barrier Underlayment Required ^h	Flood Hazards ^g	Air Freezing Index ⁱ	Mean Annual Temp ^j
			Weathering ^a	Frostline depth ^b	Termite ^e					
Table R301.2(5)	90	See Sec.R301.2.2.1 & Figure R301.2(2)	Severe	42'' See Note b	Figure R301.2(6)	See Note e	Yes	See Note g	Figure R403.3(2)	See footnote J

For SI: 1 pound per square foot = 0.0479 kN/m², 1 mile per hour = 1.609 km/h.

Ground Snow Load	WIND DESIGN				SEISMIC DESIGN CATEGORY	SUBJECT TO DAMAGE FROM			ICE BARRIER UNDERLAYMENT REQUIRED ^h	FLOOD HAZARD ^g	AIR FREEZING INDEX ⁱ	MEANANNUAL TEMP ^j
	Speed ^d (mph)	Topographic Effects ^k	Special wind region ^l	Windborne debris zone ^m		Weathering ^a	Frost Line depth ^b	Termite ^c				
Table R301.2(4)	107	No	No	No	R301.2.2.1	Severe	42"	Figure R318.4	Yes	See Footnote ^g	Figure R403.3.(2)	See Footnote ^j

MANUAL J DESIGN CRITERIA

Elevation	Altitude correction Factor ^e	Coincident wet bulb	Indoor winter design dry-bulb temperature	Indoor winter design dry bulb temperature	Outdoor winter design dry-bulb temperature	Heating temperature difference
-	-	-	-	-	-	-
Latitude	Daily range	Indoor Summer design relative Humidity	Indoor Summer design relative humidity	Indoor summer design dry-bulb temperature	Outdoor summer design dry-bulb temperature	Cooling temperature difference
-	-	-	-	-	-	-

For SI: 1 pound per square foot = 0.0479 kilopascals, 1 mile per hour = 0.447 meter /second.

(a) ~~Weathering may require a higher strength concrete or grade of masonry than necessary to satisfy the structural requirements of this code. The weathering column shall be filled in with the weathering index, (i.e., “negligible”, “moderate,” or “severe”), for concrete as determined from the weathering probability map [figure R301.2(3)]. The grade of masonry units shall be determined from~~

ASTM C 34, C 55, C 62, C 73, C 90, C 129, C 145, C 216 or C 652 as listed in chapter 44. Where weathering requires a higher strength concrete or grade of masonry than necessary to satisfy the structural requirements of this code, the frost line depth strength required for weathering shall govern. The weathering column shall be filled in with the weathering index, "negligible," "moderate," or "severe" for concrete as determined from figure R301.2(1). The grade of masonry units shall be determined from ASTM C34, ASTM C55, ASTM C62, ASTM C73, ASTM C90, ASTM C129, ASTM C145, ASTM C216, or ASTM C652.

(b) ~~The frost line depth may be modified as provided in section R403.1.4 of the code.~~ Where the frost line depth requires deeper footings than indicated in figure R403.1(1), the frost line depth strength required for weathering shall govern. The jurisdiction shall fill in the frost line depth column with the minimum depth of footing below finish grade.

(c) ~~The jurisdiction shall fill in this part of the table to indicate the need for protection depending on whether there has been a history of local damage.~~ The jurisdiction shall fill in this part of the table to indicate the need for protection depending on whether there has been a history of local subterranean termite damage.

(d) ~~The jurisdiction shall fill in this part of the table with the wind speed from the basic wind speed map, [figure R301.2(4)]. Wind exposure category shall be determined on a site-specific basis in accordance with section R301.2.1.4 of the code.~~ The jurisdiction shall fill in this part of the table with the wind speed from the basic wind speed map, figure R301.2(2). Wind exposure category shall be determined on a site-specific basis in accordance with section R301.2.1.4.

(e) ~~The winter design temperature criteria shall be taken from appendix D of the Michigan plumbing code, R 408.30701 to R 408.30796.~~ The jurisdiction shall fill in this section of the table to establish the design criteria using table 10A from ACCA Manual J or established criteria determined by the jurisdiction.

(f) ~~Design category determined from section R301.2.2.1 of the code.~~ The jurisdiction shall fill in this part of the table with the seismic design category determined from section R301.2.2.1.

(g) ~~The jurisdiction shall fill in this part of the table with both of the following:~~ The jurisdiction shall fill in this part of the table with the date of the jurisdiction's entry into the National Flood Insurance Program, which is the date of adoption of the first code or ordinance for management of flood hazard areas, and the title and date of the currently effective Flood Insurance Study or other flood hazard study.

(ih) ~~The date of the jurisdiction's entry into the national flood insurance program (date of adoption of the first code or ordinance for management of flood hazard areas).~~ In accordance with sections R905.1.2, R905.4.3.1, R905.5.3.1, R905.6.3.1, R905.7.3.1 and R905.8.3.1, where there has been a history of local damage from the effects of ice damming, the jurisdiction shall fill in this part of the table with "YES." Otherwise, the jurisdiction shall fill in this part of the table with "NO."

(ii) ~~The date(s) of the currently effective FIRM and FBFM or other flood hazard map adopted by the community, as may be amended.~~ Absent (i) or (ii), flood hazard areas as determined by the state under its administration of the Part 31, floodplain regulatory

authority of the natural resources and environmental protection act, 1994 PA 451, MCL 324.101 to 324.90106, shall become the basis for regulation of floodplain development within the community and section R408.7 of the code shall apply to buildings and structures within those areas. **The jurisdiction shall fill in this part of the table with the 100-year return period air freezing index, BF-days, from figure R403.3(2) or from the 100-year, 99 percent, value on the National Climatic Data Center data table entitled, "Air Freezing Index-USA Method (Base 32°F)."**

(hj) ~~In accordance with sections R905.2.7, R905.4.3.1, R905.5.3.1, R905.6.3.1, R905.7.3.1 and R905.8.3.1 of the code, for areas where the average daily temperature in January is 25 degrees Fahrenheit, (- 4 degrees Celsius,) or less, or where there has been a history of local damage from the effects of ice damming, the jurisdiction shall fill in this part of the table with "YES". Otherwise, the jurisdiction shall fill in this part of the table with "NO".~~ **The jurisdiction shall fill in this part of the table with the mean annual temperature from the National Climatic Data Center data table entitled, "Air Freezing Index-USA Method (Base 32°degrees Fahrenheit)."**

(ik) ~~The jurisdiction shall fill in this part of the table with the 100-year return period air freezing index, (bf days), from figure R403.3(2) or from the 100-year, (99%), value on the national climatic data center data table "air freezing index-USA method (base 32 degrees Fahrenheit)".~~ **In accordance with section R301.2.1.5, where there is local historical data documenting structural damage to buildings due to topographic wind speed-up effects, the jurisdiction shall fill in this part of the table with "YES." Otherwise, the jurisdiction shall indicate "NO" in this part of the table.**

(jl) ~~The jurisdiction shall fill in this part of the table with the mean annual temperature from the national climatic data center data table "air freezing index-USA method (base 32 degrees Fahrenheit)" at www.nedc.noaa.gov/fpsf.html~~ **In accordance with figure R301.2(2), where there is local historical data documenting unusual wind conditions, the jurisdiction shall fill In this part of the table with "YES" and identify any specific requirements. Otherwise, the jurisdiction shall indicate "NO" in this part of the table.**

(m) **In accordance with section R301.2.1.2, the jurisdiction shall indicate the wind-borne debris wind zone or zones. Otherwise, the jurisdiction shall indicate "NO" in this part of the table.**

(n) **The jurisdiction shall fill in these sections of the table to establish the design criteria using table Ia or Ib from ACCA Manual .1 or established criteria determined by the jurisdiction.**

(o) **The jurisdiction shall fill in this section of the table using the Ground Snow Loads in figures R301.2(3) and R301.2(4).**

R 408.30518 Means of egress.

Rule 518. Sections R311.6.4 and R311.2.1 are added to the code and R311.2 of the code is amended to read as follows:

R311.6.4 Modular ramps. Modular ramp systems approved pursuant to the act are not required to comply with the requirements of section R403.1.4 of the code.

R311.2. Door type and size. The required exit door shall be a side-hinged door not less than 3 feet, (914 ~~mm~~-**millimeters**), in width and 6 feet, 8 inches, (2,032 ~~mm~~-**millimeters**), in height. Other exterior hinged or sliding doors shall not be less than 24 inches (6,096 ~~mm~~ **millimeters**) in width and 6 feet, 6 inches, (1,981 ~~mm~~-**millimeters**), in height.

R311.2.1. Interior doors. Interior doors shall be not less than 24 inches, (6,096 ~~mm~~ **millimeters**), in width and 6 feet, 6 inches, (1,524 ~~mm~~-**millimeters**), in height.

Exception: Doors to areas less than 10 square feet of floor area.

R 408.30519 Treads and risers.

Rule 519. Sections R311.7.4-5.1 and R 311.7.4-5.2 of the code are amended to read as follows:

R311.7.5.1. Riser height. The maximum riser height shall be 8-1/4 inches, (210 ~~mm~~ **millimeters**). The riser shall be measured vertically between leading edges of the adjacent treads. The greatest riser height within any flight of stairs shall not exceed the smallest by more than 3/8 inch, (9.5 ~~mm~~-**millimeters**).

R311.7.5.2. Tread depth. The minimum tread depth shall be 9 inches, (229 ~~mm~~ **millimeters**). The tread depth shall be measured horizontally between the vertical planes of the foremost projection of adjacent treads and at a right angle to the tread's leading edge. The greatest tread depth within any flight of stairs shall not exceed the smallest by more than 3/8 inch, (9.5 ~~mm~~ **millimeters**). Winder treads shall have a minimum tread depth of 10 inches, (254 ~~mm~~-**millimeters**), measured as above at a point 12 inches, (305 ~~mm~~ **millimeters**), from the side where the treads are narrower. Winder treads shall have a minimum tread depth of 6 inches, (152 ~~mm~~-**millimeters**), at any point. Within any flight of stairs, the greatest winder tread depth at the 12-inch, (305 ~~mm~~-**millimeters**), walk line shall not exceed the smallest by more than 3/8 inch, (9.5 ~~mm~~-**millimeters**).

R 408.30521 ~~Elevation requirements.~~ **Rescinded.**

~~Rule 521. Section R322.2.1 of the code is amended to read as follows;~~

~~R322.2.1. Elevation requirements. (1) Buildings and structures shall have the lowest floor including basements elevated so the lowest point of the floor's concrete or subfloor surface is 1 foot (305 mm) or more above the design flood elevation. The bottom of the lowest horizontal structural member of the floor system shall not be lower than the design flood elevation. Compliance with this elevation requirement shall be based upon measurement taken from the floor surface without the final floor covering and from the bottom of the lowest horizontal structural member of the floor system.~~

~~(2) Crawl space interior floor grade elevation shall comply with R408.6 of the code.~~

~~(3) Basement floors that are below grade on all sides shall be considered lowest floors and shall be elevated so that the lowest point of the floor surface is 1 foot (305 mm) or more above the design flood elevation.~~

~~Compliance with this elevation requirement shall be based upon measurement taken from the floor surface without the final floor covering.~~

~~Exception: Enclosed areas below the design flood elevation, including basements that have floors which are not below grade on all sides, shall meet the requirements of section R322.2.2 of the code.~~

R 408.30521a Rooftop mounted photovoltaic panel systems.

Rule 521a. Sections R9097.1, R9097.2, and R9097.3 of the code are added to read as follows:

R9097.1. General. The installation of photovoltaic panel systems that are mounted on or above the roof covering shall comply with the provisions of this code, Section R324, and NFPA 70.

R9097.2. Structural requirements. Rooftop mounted photovoltaic panel systems shall be designed to structurally support the system and withstand gravity loads in accordance with chapter 3. The roof upon which these systems are installed shall be designed and constructed to support the loads imposed by such systems in accordance with chapter 8.

R9097.3. Installation. Rooftop mounted photovoltaic systems shall be installed in accordance with the manufacturer’s instructions. Roof penetrations shall be flashed and sealed in accordance with this chapter.

R 408.30522a Vapor retarders. **Rescinded.**

~~Rule 522a. Section R601.3 of the code is amended to read as follows:~~

~~R601.3. Vapor retarders. Class I or II vapor retarders shall be provided on the interior side of frame walls in zones 5, 6, 7, 8, and marine 4.~~

~~Exceptions:~~

~~1. As permitted in table R702.7.1.~~

~~2. Class III or no vapor retarder shall be permitted on the interior side of below grade wall assemblies. Class I or II vapor retarders shall be permitted on the interior side of the wall assembly when no air permeable insulation is installed in the below grade wall assemblies.~~

~~3. Construction where moisture or its freezing will not damage the materials.~~

R 408.30522b Air freezing index. **Rescinded.**

~~Rule 522b. Table R403.3(2) of the code is amended to read as follows:~~

~~Table R403.3(2)~~

~~Air Freezing Index for Michigan Locations by County~~

1500 or	2000	2500	3000	3500	4000
--------------------	-----------------	-----------------	-----------------	-----------------	-----------------

Berrien Branch Cass Kalamazoo Macomb Ottawa St. Clair St. Joseph	All counties not listed	Alger Charlevoix Cheboygan Chippewa Crawford Delta Emmet Iosco-Kalkaska Lake Luce Mackinae Menominee Missaukee Montmoreney Ogemaw Oseeola Otsego Roscommon Schoolcraft Wexford	Baraga Dickinson Iron Keweenaw Marquette	Gogebie Houghton Ontonagon
---	-------------------------------	---	--	----------------------------------

R 408.30523 Placement of lag screws or bolts in deck ledgers and band joists. **Rescinded.**
~~Rule 523. Figure R507.2.1(1) of the code is amended to read as follows:~~

FIGURE R507.2.1(1)
 PLACEMENT OF LAG SCREWS AND BOLTS IN LEDGERS

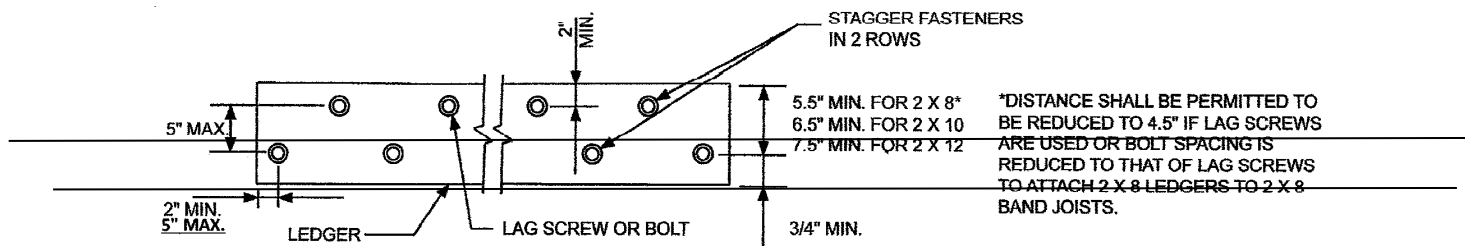

R408.30523a Flashing. **Rescinded.**

~~Rule 523a. Section R507.2.4 is added and figure R507.2.1(2) is amended to read as follows:~~

~~R507.2.4. Flashing. An approved corrosion resistant flashing as required by Section R703.8 shall be installed above the attached ledger as shown in figure R507.2.1(2) or as approved.~~

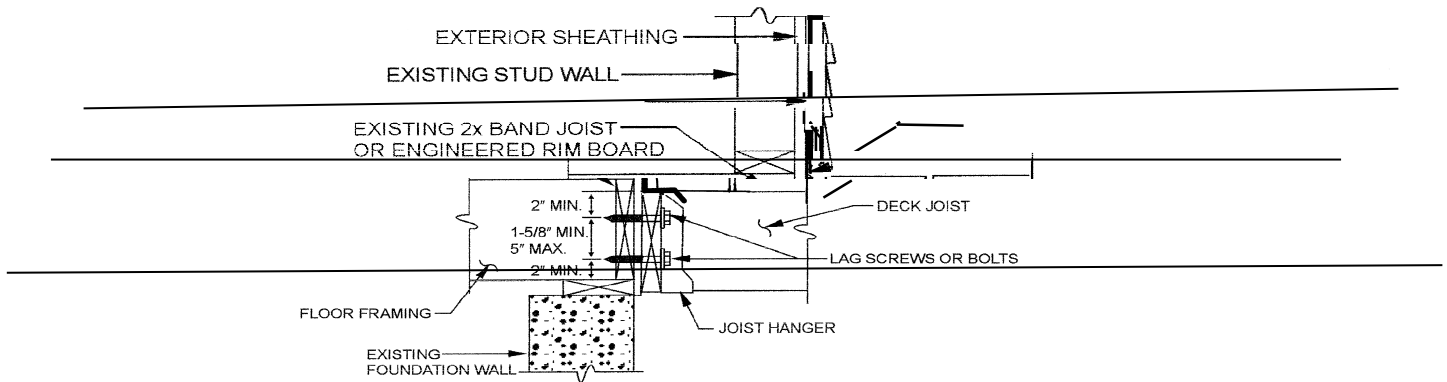

For SI: 1 inch = 25.4 mm.

FIGURE R507.2.1(2)
PLACEMENT OF LAG SCREWS AND BOLTS IN BAND JOISTS

R 408.30524 Michigan uniform energy code.

Rule 524. Buildings shall be designed and constructed in accordance with the Michigan uniform energy code part 10 rules, R 408.3100159 to R 408.3109971a.

R 408.30525a ~~Simplified wall bracing. Rescinded.~~

~~Rule 525a. Section R602.10.9 is amended to read as follows:~~

~~R602.10.9. Braced wall panel support. Braced wall panel support shall be provided as follows:~~

- ~~1. Cantilevered floor joists complying with section R502.3.3 shall be permitted to support braced wall panels.~~
- ~~2. Raised floor system post or pier foundations supporting braced wall panels shall be designed in accordance with accepted engineering practice.~~
- ~~3. Masonry stem walls with a length of 48 inches (1 219 mm) or less supporting braced wall panels shall be reinforced in accordance with figure R602.10.9. Masonry stem walls with a length greater than 48 inches (1 219 mm) supporting braced wall panels shall be constructed in accordance with section R403.1. Methods ABW and PFH shall not be permitted to attach to masonry stem walls.~~
- ~~4. Concrete stem walls with a length of 48 inches (1 219 mm) or less, greater than 12 inches (305 mm) tall shall have reinforcement sized and located in accordance with figure R602.10.9.~~

R 408.30528 Terms defined in other codes. ~~Rescinded.~~

~~Rule 528. Section G2402.3 of the code is amended to read as follows:~~

~~G2402.3. Terms defined in other codes. Where terms are not defined in the code and are defined in the Michigan electrical code, R 408.30801 to R 408.30880, Michigan building code, R 408.30401 to R 408.30547, international fire code and international fuel gas code listed in chapter 44, Michigan mechanical code, R 408.30901 to R 408.30998 or Michigan plumbing code, R 408.30701 to R 408.30796, the terms shall have the meanings ascribed to them as in those codes.~~

R 408.30528a CSST. Rescinded.

~~Rule 528a. Section G2411.1.1 (310.1.1) of the code is amended to read as follows:~~

~~G2411.1.1. CSST. Corrugated stainless steel tubing (CSST) gas piping systems shall be bonded to the electrical service grounding electrode system or where provided, lightning protection electrode system. The bonding jumper shall connect to a metallic pipe, pipe fitting, or CSST fitting between the point of delivery and the CSST utilizing a device listed for the application. The bonding jumper shall be not smaller than 6 AWG copper wire or equivalent, not longer than 75 feet and accessible. Gas piping systems that are bonded in accordance with this section shall be considered effectively bonded regardless of the amount of CSST in the system. Any additional grounding electrodes used shall be bonded to the electrical service grounding electrode system, or where provided, the lightning protection grounding electrode system.~~

~~Exception: CSST piping systems tested and listed by the manufacturer for installation without additional bonding when installed in accordance with the listing.~~

R 408.30529 Lining required.

Rule 529. Section P2709.2 of the code is amended to read as follows:

P2709.2. Lining required. The adjoining walls and floor framing enclosing on-site built-up shower receptors shall be lined with 1 of the following:

1. Sheet lead.
2. Sheet copper.
3. Plastic liner material that complies with ASTM D 4068 or ASTM D 4551.
4. Sheet-applied load-bearing, bonded waterproof membranes that comply with ANSI A118.10.

The lining material shall extend not less than 3 inches, (~~76 mm millimeters~~), beyond or around the rough jambs and not less than 3 inches, (~~76 mm millimeters~~), above finished thresholds. Sheet-applied load bearing, bonded waterproof membranes shall be applied in accordance with the manufacturer's instructions.

R 408.30530 Requirements for discharge pipe.

Rule 530. Section P2803 4.6.1 of the code is amended to read as follows:

~~P2803 4.6.1. Requirements for discharge pipe. Relief valves shall not discharge so as to be a hazard, a potential cause of damage, or a nuisance.~~

A relief valve discharge pipe shall be provided for each individual relief valve and shall meet all of the following:

- (a) Shall terminate atmospherically not more than 4 inches, (~~102 mm millimeters~~), from the floor with an unthreaded end.

- (b) Shall not be interconnected.
 - (c) Valves shall not be connected in the relief valve discharge pipe.
 - (d) Shall be rigid pipe approved for water distribution, with a minimum temperature rating of 210 degrees Fahrenheit.
 - (e) Shall have the same nominal inside diameter as the relief valve outlet and shall drain by gravity flow.
 - (f) Shall discharge to the floor, or to the pan serving the water heater or storage tank, or to a waste receptor.
- The outlet of a pressure, temperature, or other relief valve shall not be directly connected to the drainage system.

R 408.30532 Roof extension.

Rule 532. Section P3103.1 of the code is amended to read as follows:

P3103.1. Roof extension. All open vent pipes that extend through a roof shall terminate at least 1 foot, (~~305 mm~~ **millimeters**), above the roof, except that if a roof is to be used for any purpose other than weather protection, then the vent extension shall be run not less than 7 feet, (~~2,134 mm~~ **millimeters**), above the roof.

R 408.30533 Frost closure.

Rule 533. Section P3103.2 of the code is amended to read as follows:

P3103.2. Frost closure. To prevent frost closure, every vent extension through a roof shall be not less than 3 inches, (~~76 mm~~ **millimeters**), in diameter. Any increase in the size of the vent shall be made inside the building with a minimum of 1 foot, (~~305 mm~~ **millimeters**), below the roof or inside the wall.

R 408.30533a Rough plumbing.

Rule 533a. Section P2503.5.1 of the code is amended **and P2503.8, P2503.8.1 and P2503.8.2 are added** to read as follows:

P2503.5.1. Rough plumbing. DWV systems shall be tested on completion of the rough piping installation by water or air with no evidence of leakage. Either test shall be applied to the drainage system in its entirety or in sections after rough piping has been installed, as follows:

1. Water test. Each section shall be filled with water to a point not less than 10 feet, (~~3,048 mm~~ **millimeter**), above the highest fitting connection in that section, or to the highest point in the completed system. Water shall be held in the section under test for a period of 15 minutes. The system shall prove leak free by visual inspection.

2. Air test. The portion under test shall be maintained at a gauge pressure of 5 pounds per square inch (psi), (~~34 kPa~~ **kilopascals**), or 10 inches, (~~254 mm~~ **millimeters**), of mercury column, (~~34 kPa~~ **kilopascals**). This pressure shall be held without introduction of additional air for a period of 15 minutes.

P2503.8 Inspection and testing of backflow prevention devices. Inspection and testing of backflow prevention devices shall comply with sections P2503.8.1 and P2503.8.2.

P2503.8.1 Inspections. Inspections shall be made of backflow prevention assemblies to determine whether they are operable.

P2503.8.2 Testing. Reduced pressure principle, double check, double check detector, and pressure vacuum breaker backflow preventer assemblies shall be tested at the time of installation and immediately after repairs or relocation.

R 408.30533b Sewer depth.

Rule 533b. Section P2603.5.1 of the code is amended to read as follows:

P2603.5.1. Sewer depth. A building sewer that connects to a private disposal system shall be a minimum of 8 inches, (~~203 mm~~ **millimeters**), to the top of the pipe below finished grade at the point of septic tank connection. Building sewers shall be installed a minimum of 42 inches, (~~1,067 mm~~ **millimeters**), below grade.

Exception: When permitted by the code official.

R 408.30533c Pipe fittings.

Rule 533c. Section P2906.6 is added to the code to read as follows:

Pipe Fittings

MATERIAL	STANDARD
Acrylonitrile butadiene styrene (ABS) plastic	ASTM D2468
Cast-iron	ASME B16.4
Chlorinated polyvinyl chloride (CPVC) plastic	ASSE 1061; ASTM D2846; ASTM F437; ASTM F438; ASTM F439; CSA B137.6
Copper or copper alloy	ASSE 1061; ASME B16.15; ASME B16.18; ASME B16.22; ASME B16.26; ASME B16.51
Cross-linked polyethylene/aluminum/high-density polyethylene (PEX-AL-HDPE)	ASTM F1986
Fittings for cross-linked polyethylene (PEX) plastic tubing	ASSE 1061; ASTM F877; ASTM F1807; ASTM F1960; ASTM F2080; ASTM F2098; ASTM F2159; ASTM F2434; ASTM F2735; CSA B137.5
Gray iron and ductile iron	AWWA C110/A21.10; AWWA C153/A21.53
Galvanized steel pipe	ASTM A53
Malleable iron	ASME B16.3
Insert fittings for Polyethylene/aluminum/polyethylene (PE-AL-PE) and cross-linked polyethylene/aluminum/cross-linked polyethylene (PEX-AL-PEX)	ASTM F1974; ASTM F1281; ASTM F1282; CSA B137.9; CSA B137.10
Polyethylene (PE) plastic	ASTM D2609; CSA B137.1
Fittings for polyethylene of raised temperature (PE-RT) plastic tubing	ASTM F1807; ASTM F2098; ASTM F2159; ASTM F2735; ASTM F2769
Polypropylene (PP) plastic pipe or tubing	ASTM F2389; CSA B137.11
Polyvinyl chloride (PVC) plastic	ASTM D2464; ASTM D2466; ASTM D2467; CSA B137.2; CSA B137.3
Stainless steel (Type 304/304L) pipe	ASTM A312; ASTM A778
Stainless steel (Type 316/316L) pipe	ASTM A312; ASTM A778
Steel	ASME B16.9; ASME B16.11; ASME B16.28

R 408.30534 Venting.

Rule 534. Section P3105.1 is amended and section 3105.4 and figure P3105.4 are added to the code and figure N3 in appendix N of the code is amended to read as follows:

P3105.1. Distance of trap from vent. Each fixture trap shall have a protecting vent located so that the slope and the developed length in the fixture drain from the trap weir to the vent fitting are within the requirements in table P3105.1 of the code.

P3105.4. Vertical leg for waste fixture drains. A vertical leg, (see figure P3105.4), is permitted within a fixture drain of a waste fixture in accordance with the following criteria:

- (1) Minimum trap diameter shall be in accordance with table P3201.7 of the code.
- (2) The diameter of section A shall be equal to the diameter of the trap.
- (3) The length of section A shall not be less than 8 inches, (~~2,032 mm-millimeters~~), and in accordance with table P3105.1 of the code.
- (4) The diameter of section B shall be 1 pipe size larger than the diameter of section A.
- (5) The length of section B shall not be more than 36 inches, (~~9,144 mm-millimeters~~).
- (6) The diameter of section C shall be 1 pipe size larger than the diameter of section B.
- (7) The total length of section A and section C shall not exceed the distance allowed in table P3105.1 of the code.
- (8) Bends shall be the diameter of the largest connected section.

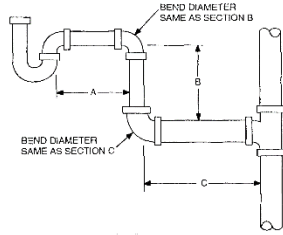
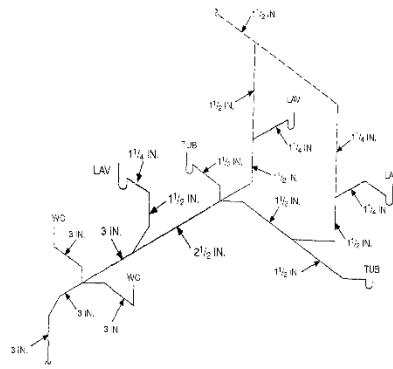

FIGURE P3105.4
VERTICAL LEG FIXTURE DRAIN SCHEMATIC

Figure N3. Typical horizontal wet venting.



74-55 1 inch = 25.4 mm

Note: The lower lavatory connected to the horizontal part of the wet vent illustrates a portion of Section P3105.4 Vertical leg for waste fixture drains.

FIGURE N3
TYPICAL HORIZONTAL WET VENTING

R 408.30535 Connection.

Rule 535. Section P3111.2.2 of the code is amended to read as follows:

P3111.2.2. Connection. The combination waste and vent systems shall be provided with a dry vent connected to a point within the system or the system shall connect to a horizontal drain that is vented in accordance with one of the methods specified in this chapter. Combination waste and vent systems connecting to building drains receiving only the discharge from a stack or stacks shall be provided with a dry vent. The vent connecting the combination waste and vent pipe shall extend vertically not less than 6 inches, (152 ~~mm~~ **millimeters**), above the flood level rim of the highest fixture being vented before offsetting horizontally.

R 408.30536 Electrical; general; electrical conductors; connections and electrical grounding.

Rule 536. Sections E3401.1, ~~E3401.2, E3401.3, E3705.4.1, E3908.8.1, and E3908.8.2~~ of the code ~~are~~ is amended and ~~E3401.5, E3401.6, E3401.6.1, E3401.6.2, E3401.6.3, E3401.7, and E3401.8~~ are added to read as follows:

E3401.1. **Applicability Scope. This chapter governs the electrical components, equipment and systems used in buildings and structures covered by this code. Electrical components, equipment and systems shall be designed and constructed in accordance with the provisions of the Michigan electrical code, R 408.30801 to R 408.30873.** ~~The provisions of chapters 34 to 43 of the code shall establish the general scope of the electrical system and equipment requirements of the code. Chapters 34 to 43 of the code cover those wiring methods and materials most commonly encountered in the construction of 1- and 2- family dwellings and structures regulated by the code. Other wiring methods, materials, and subject matter covered in the Michigan electrical code, R 408.30801 to R 408.30880 are also allowed by the code.~~

~~E3401.2. Scope. Chapters 34 to 43 of the code shall cover the installation of electrical systems, equipment, and components indoors and outdoors that are within the scope of the code, including services, power distribution systems, fixtures, appliances, devices, and appurtenances. Services within the scope of the code shall be limited to 120/240 volt, 0- to 400- ampere, single-phase systems. These chapters specifically cover the equipment, fixtures, appliances, wiring methods, and materials that are most commonly used in the construction or alteration of 1- and 2- family dwellings and accessory structures regulated by the code. The omission from these chapters of any material or method of construction provided by the Michigan electrical code, R 408.30801 to R 408.30880, shall not be construed as prohibiting the use of such material or method of construction. Electrical systems, equipment, or components not specifically covered in these chapters shall comply with the applicable provisions of the Michigan electrical code, R 408.30801 to R 408.30880.~~

~~E3401.3. Not covered. Chapters 34 to 43 do not cover the following:~~

~~(1) Installations under the exclusive control of communications utilities and electric utilities.~~

~~(2) Services over 400 amperes.~~

~~E3401.5. General. This section provides for the design, construction, installation, alteration, and repair of photovoltaic equipment and systems. [690.1]~~

~~E3401.6. Requirements. The installation, inspection, maintenance, repair, and replacement of photovoltaic systems and all system components shall comply with the manufacturer's instructions, Sections E3401.6.1 through E3401.6.3 and NFPA 70. [690.3]~~

~~E3401.6.1. Roof-mounted panels and modules. Where photovoltaic panels and modules are installed on roofs, the roof shall be constructed to support the loads imposed by such modules. Roof-mounted photovoltaic panels and modules that serve as roof covering shall conform to the requirements for roof coverings in chapter 9. Where mounted on or above the roof coverings, the photovoltaic panels and modules and supporting structure shall be constructed of noncombustible materials or fire-retardant treated wood equivalent to that required for the roof construction.~~

~~E3401.6.2. Roof and wall penetrations. Roof and wall penetrations shall be flashed and sealed in accordance with chapter 9 to prevent entry of water, rodents, and insects.~~

~~E3401.6.3. Ground-mounted panels and modules. Ground-mounted panels and modules shall be installed in accordance with the manufacturer's instructions. [110.3(B)]~~

~~E3401.7. Photovoltaic panels and modules. Photovoltaic panels and modules shall be listed and labeled in accordance with UL 1703. [690.4(B)]~~

~~E3401.8. Inverters. Inverters shall be listed and labeled in accordance with UL 1741. Systems connected to the utility grid shall use inverters listed for utility interaction. [690.4(B)]~~

~~E3705.4.1. Conductors rated 60°C. Except where the equipment is marked otherwise, termination provisions of equipment for circuits rated 100 amperes or less, or marked for 14 AWG through 1 AWG conductors, shall be used only for 1 of the following:~~

~~1. Conductors rated 60°C (140°F).~~

~~2. Conductors with higher temperature ratings, provided that the ampacity of such conductors is determined based on the 60°C (140°F) ampacity of the conductor size used.~~

~~3. Conductors with higher temperature ratings where the equipment is listed and identified for use with such conductors. [110.14(C)(1)(a)]~~

~~E3908.8.1. Grounding of flexible metal conduit. Flexible metal conduit shall not be permitted as an equipment grounding conductor. [Michigan Electrical Code Rules Part 8 250.118 amended]~~

~~E3908.8.2. Grounding of liquid-tight flexible metal conduit. Liquid-tight flexible metal conduit shall not be permitted as an equipment grounding conductor. [Michigan Electrical Code Rules Part 8 250.118 amended]~~

R 408.30536a—General requirements.—Rescinded.

~~Rule 536a. Sections E3402.2, E3405.2 and E3407.5 are amended to read as follows:~~

~~E3402.2. Penetrations of fire-resistance-rated assemblies. Electrical installations in hollow spaces, vertical shafts, and ventilation or air-handling ducts shall be made so that the possible spread of fire or products of combustion will not be substantially increased. Electrical penetrations through fire-resistance-rated walls, partitions, floors, or ceilings shall be protected by approved methods to maintain the fire-resistance rating of the element penetrated. Penetrations of fire-resistance-rated walls shall be limited as specified in Section R302.4.~~

~~E3405.2. Working clearances for energized equipment and panelboards. Except as otherwise specified in chapters 34 through 43, the dimension of the working space in the direction of access to panelboards and live parts likely to require examination, adjustment,~~

~~servicing, or maintenance while energized shall be not less than 36 inches, (914 mm millimeters), in depth. Distances shall be measured from the energized parts where such parts are exposed or from the enclosure front or opening where such parts are enclosed. In addition to the 36-inch dimension, (914 mm millimeters), the work space shall not be less than 30 inches, (762 mm millimeters), wide in front of the electrical equipment and not less than the width of such equipment. The work space shall be clear and shall extend from the floor or platform to a height of 6.5 feet, (1,981 mm millimeters), or the height of the equipment, whichever is greater. In all cases, the work space shall allow at least a 90-degree, (1.57 radians), opening of equipment doors or hinged panels. Equipment associated with the electrical installation located above or below the electrical equipment shall be permitted to extend not more than 6 inches, (152 mm millimeters), beyond the front of the electrical equipment. [110.26(A)]~~

~~–Exception:~~

~~–1. In existing dwelling units, service equipment, and panelboards that are not rated in excess of 200 amperes may be in spaces where the height of the working space is less than 6.5 feet, (1,981 mm millimeters), but greater than 5 feet, (1,524 mm millimeters). [110.26(A)(3) Exception 1 amended]~~

~~–2. Meters that are installed in meter sockets may extend beyond the other equipment. Meter sockets shall not be exempt from the requirements of this section. [110.26(A)(3) Exception 2]~~

~~–E3407.5. Polarity of connections. No grounded conductor shall be attached to any terminal or lead so as to reverse the designated polarity.~~

~~R 408.30537–Separate outdoor electric space conditioning equipment. Rescinded.~~

~~–Rule 537. Section E3601.6.3, E3601.6.4, and E3608.1.2.1 are added to the code and Sections E3604.2.1, and E3609.7.1 are amended to read as follows:~~

~~–E3601.6.3. Separate outdoor electric space conditioning equipment. A service disconnect for separately metered outdoor electric space conditioning equipment shall be grouped with the service disconnecting means for the structure or immediately adjacent to the outdoor meter cabinet. A permanent plaque or directory shall be installed at each service disconnect location denoting the other services, feeders, and branch circuits supplying a building or structure and area served by each service, feeder, and branch circuit. Grounding shall be in accordance with Sections E3607 and E3608.~~

~~–E3601.6.4. Electric vehicle charging system service disconnect. A service disconnect for electric vehicle charging systems shall be grouped with the service disconnecting means for the structure or immediately adjacent to the outdoor meter cabinet. A permanent plaque or directory shall be installed at each service disconnect location identifying the other services, feeders, and branch circuits supplying a building or structure and area served by each service, feeder, and branch circuit. Grounding shall be in accordance with Section E3607 and E3608.~~

~~–E3604.2.1. Above roofs. Conductors shall have a vertical clearance of not less than 8 feet, (2,438 mm millimeters), above the roof surface. The vertical clearance above the roof level shall be maintained for a distance of not less than 3 feet, (914 mm millimeters), in all directions from the edge of the roof. See figure E3604.2.1. [230.24(A)]~~

~~–Exceptions:~~

- ~~1. Conductors above a roof surface subject to pedestrian traffic shall have a vertical clearance from the roof surface in accordance with Section E3604.2.2. [230.24(A) Exception 1]~~
- ~~2. Where the roof has a slope of 4 inches, (102 mm **millimeters**), in 12 inches, (305 mm **millimeters**), or greater and is not accessible from an operable window, the minimum clearance shall be 3 feet, (914 mm **millimeters**). [230.24(A) Exception 2 amended]~~
- ~~3. The minimum clearance above only the overhanging portion of the roof shall not be less than 18 inches, (457 mm **millimeters**), where not more than 6 feet, (1,829 mm **millimeters**), of conductor length passes over 4 feet, (1,219 mm **millimeters**), or less of roof surface measured horizontally and such conductors are terminated at a through-the-roof raceway or approved support. [230.24(A) Exception 3]~~
- ~~4. The requirement for maintaining the vertical clearance for a distance of 3 feet, (914 mm **millimeters**), from the edge of the roof shall not apply to the final conductor span where the service drop is attached to the side of a building. [230.24(A) Exception 4]~~
- ~~5. Where the voltage between conductors does not exceed 300 and the roof area is guarded or isolated, a reduction in clearance to 3 feet, (914 mm **millimeters**), shall be permitted. [230.24(A) Exception 5]~~
- ~~E3608.1.2.1. Verification of the installation of the concrete encased electrode specified for in E3608.1.2. The inspection of a concrete encased electrode meeting the requirements of E3608.1.2 except for the connection of the grounding electrode conductor to the electrode shall be completed by 1 of the following:~~
 - ~~1. The electrical inspector for the enforcing agency.~~
 - ~~2. The building inspector for the enforcing agency if all of the following conditions are met:~~
 - ~~a. Both the electrical and building inspectors for the enforcing agency(s) shall sign a written agreement which shall remain on file with the enforcing agency that designates authority to the building inspector for that agency to inspect a concrete encased electrode.~~
 - ~~b. Upon inspection and verification by the building inspector of a concrete encased electrode, the building inspector shall provide written documentation to the electrical inspector that the installation of the concrete encased electrode meets the requirements set forth in E3608.1.2. Electrode shall be ½" diameter, (13mm **millimeters**), reinforcing bar or larger, a minimum of 20 feet, (6,096 mm **millimeters**), long including usual tie wire connections, and encased in 2 inches, (51 mm **millimeters**), of concrete except for the end of the electrode which shall be in an accessible location and not subject to deteriorating conditions (i.e. backfill).~~
 - ~~c. Verification of approval of the concrete encased electrode shall be made at the construction site by signature of the field copy of the building permit noting that the concrete encased electrode was approved along with the footing inspection or by a readily available inspection tag attached to the accessible grounding electrode reinforcing bar.~~
 - ~~d. The grounding electrode conductor connection to the concrete encased electrode shall be inspected by the electrical inspector for the enforcing agency.~~
- ~~E3609.7.1. Corrugated stainless steel tubing (CSST). Corrugated stainless steel tubing gas piping systems shall be bonded to the electrical service grounding electrode system or where provided, lightning protection electrode system. The bonding jumper shall connect to a metallic pipe, pipe fitting, or CSST fitting between the point of delivery and the CSST utilizing a device listed for the application. The bonding jumper shall be not smaller than~~

~~6 AWG copper wire or equivalent, not longer than 75 feet, (22,860 millimeters), and accessible. Gas piping systems that are bonded in accordance with this section shall be considered effectively bonded regardless of the amount of CSST in the system. Any additional grounding electrodes used shall be bonded to the electrical service grounding electrode system, or where provided, the lighting protection grounding electrode system. Exception: CSST piping systems tested and listed by the manufacturer for installation without additional bonding when installed in accordance with the listing.~~

R 408.30537a—Wiring methods. Rescinded.

~~Rule 537a. Section E3803.6 and tables E3801.4, and E3802.1 are amended to read as follows:~~

~~E3803.6. Raceway seals. Conduits or raceways shall be sealed or plugged at either or both ends where moisture will enter and contact live parts. Sealants shall be identified for use with the cable insulation, shield, or other components.~~

Table E3801.4
 ALLOWABLE APPLICATIONS FOR WIRING METHODS^{a, b, c, d, e, f, g, h, i, j, k, l}

ALLOWABLE APPLICATIONS (application allowed where marked with an "A")	AC	EMT	ENT	FMC	IMC RMC PVC	LFC ^a	MC	NM	SR	SE	UF	USE ^l
Services	—	A	A ^h	A ⁱ	A	A ⁱ	A	—	—	A	—	A
Feeders	A	A	A	A	A	A	A	A	—	A ^b	A	A ^b
Branch circuits	A	A	A	A	A	A	A	A	A	A ^c	A	—
Inside a building	A	A	A	A	A	A	A	A	A	A	A	—
Wet locations exposed to sunlight	—	A	A ^h	—	A	A	A	—	—	A	A ^e	A ^e
Damp locations	—	A	A	A ^d	A	A	A	—	—	A	A	A
Embedded in noncinder concrete in dry location	—	A	A	—	A	A ^j	—	—	—	—	—	—
In noncinder concrete in contact with grade	—	A ^f	A	—	A ^f	A ^j	—	—	—	—	—	—
Embedded in plaster not exposed to dampness	A	A	A	A	A	A	A	—	—	A	A	—
Embedded in masonry	—	A	A	—	A ^f	A	A	—	—	—	—	—
In masonry voids and cells exposed to dampness or below grade line	—	A ^f	A	A ^d	A ^f	A	A	—	—	A	A	—
Fished in masonry voids	A	—	—	A	—	A	A	A	—	A	A	—
In masonry voids and cells not exposed to dampness	A	A	A	A	A	A	A	A	—	A	A	—
Run exposed	A	A	A	A	A	A	A	A	A	A	A	—
Run exposed and subject to physical damage	—	—	—	—	A ^g	—	—	—	—	—	—	—
For direct burial	—	A ^f	—	—	A ^f	A	A ^f	—	—	—	A	A

For SI: 1 foot = 304.8 mm millimeters.

- a. Liquid-tight flexible nonmetallic conduit without integral reinforcement within the conduit wall shall not exceed 6 feet in length.
- b. Type USE cable shall not be used inside buildings.
- c. The grounded conductor shall be insulated.
- d. Conductors shall be a type approved for wet locations and the installation shall prevent water from entering other raceways.
- e. Shall be listed as "sunlight resistant."

- f. Metal raceways shall be protected from corrosion and approved for the application. Aluminum RMC requires approved supplementary corrosion protection.
- g. RNC shall be Schedule 80.
- h. Shall be listed as “sunlight resistant” where exposed to the direct rays of the sun.
- i. Conduit shall not exceed 6 feet in length.
- j. Liquid-tight flexible nonmetallic conduit may be encased in concrete where listed for direct burial and only straight connectors listed for use with LFNC are used.
- k. In wet locations under any of the following conditions:
 - (i) The metallic covering is impervious to moisture.
 - (ii) A lead sheath or moisture impervious jacket is provided under the metal covering.
 - (iii) The insulated conductors under the metallic covering are listed for use in wet locations and a corrosion-resistant jackets is provided over the metallic sheath.
- l. Type USE cable not permitted above ground except to terminate at the exterior of a building in an approved enclosure and protected in accordance with Section E3803.3.

TABLE E3802.1
GENERAL INSTALLATION AND SUPPORT REQUIREMENTS FOR WIRING METHODS^{a, b, c, d, e, f, g, h, i, j, k}

INSTALLATION REQUIREMENTS (Requirement applicable only to wiring methods marked “A”)	AC MC	EMT IMC RMC	ENT	F MC L FC	M F	P VC	S E	S R ^a
Where run parallel with the framing member or furring strip, the wiring shall be not less than 1 ¼ inches from the edge of a furring strip or a framing member such as a joist, rafter, or stud or shall be physically protected.	A	=	A	A		=	A	=
Bored holes in framing members for wiring shall be located not less than 1 ¼ inches from the edge of the framing member or shall be protected with a minimum 0.0625 inch steel plate or sleeve, a listed steel plate, or other physical protection.	A ^k	=	A ^k	A _k	k	=	A _k	=
Where installed in grooves, to be covered by wallboard, siding, paneling, carpeting, or similar finish, wiring methods shall be protected by 0.0625-inch-thick steel plate, sleeve, or equivalent, a listed steel plate or by not less than 1 ¼ inch free space for the full length of the groove in which the cable or raceway is installed.	A	=	A	A		=	A	A
Securely fastened bushings or grommets shall be provided to protect wiring run through openings in metal framing members.	=	=	A ^j	=	j	=	A _j	=
The maximum number of 90-degree bends shall not exceed 4 between junction boxes.	=	A	A	A		A	=	=
Bushings shall be provided where entering a box, fitting, or enclosure unless the box or fitting is designed to afford equivalent protection.	A	A	A	A		A	=	A

Ends of raceways shall be reamed to remove rough edges.	=	A	A	A		A	=	A
Maximum allowable on center support spacing for the wiring method in feet.	4.5 ^b e	10 ^l	3 ^b	4 5 ^b	5 ⁱ	3 d+1	2 5 ^e	-
Maximum support distance in inches from box or other terminations.	12 ^b f	36	36	1 2 ^b , ^g	2 h i	3 6	1 2	-

For SI: 1 inch = 25.4 mm **millimeters**, 1 foot = 304.8 mm **millimeters**, 1 degree = 0.0175 **radians**.

- a. Installed in accordance with listing requirements.
- b. Supports not required in accessible ceiling spaces between light fixtures where lengths do not exceed 6 feet.
- c. Six feet for MC cable.
- d. Five feet for trade sizes greater than 1 inch.
- e. Two and one half feet where used for service or outdoor feeder and 4.5 feet where used for branch circuit or indoor feeder.
- f. Twenty four inches for Type AC cable and 36 inches for interlocking Type MC cable where flexibility is necessary.
- g. Where flexibility after installation is necessary, lengths of flexible metal conduit and liquidtight flexible metal conduit measured from the last point where the raceway is securely fastened shall not exceed: 36 inches for trade sizes ½ through 1 ¼, 48 inches for trade sizes 1 ½ through 2 and 5 feet for trade sizes 2 ½ and larger.
- h. Within 8 inches, (203 mm **millimeters**), of boxes without cable clamps.
- i. Flat cables shall not be stapled on edge.
- j. Bushings and grommets shall remain in place and shall be listed for the purpose of cable protection.
- k. See Section R502.8 and R802.7 for additional limitations on the location of bored holes in horizontal framing members.
- l. Raceways may be unsupported where the raceway is not more than 900 millimeters (36 inches) long and remains in unbroken lengths (without coupling). Such raceways shall terminate in an outlet box, junction box, device box, cabinet, or other termination at each end of the raceway.

R 408.30537b ~~Power and lighting distribution.~~**Rescinded.**

~~Rule 537b. Sections E3901.11, E3905.3.2, E3908.9, and E3908.10, are amended and E3908.9.1, E3908.9.1.1 and E3908.9.1.2 are added to read as follows:~~

~~E3901.11. Foyers. Foyers that are not part of a hallway in accordance with Section E3901.10 and that have an area that is greater than 100 feet², (9.2903 m² **meters squared**), shall have a receptacle(s) located in each wall space that is 3 feet, (914 mm **millimeters**), or more in width. Doorways, door-side windows that extend to the floor and similar openings shall not be considered as wall space. [210.52(I) amended]~~

~~E3905.3.2. Securing to box. All permitted wiring methods shall be secured to the boxes.~~

~~Exception: Where nonmetallic sheathed cable is used with boxes not larger than a nominal size of 2-¼ inches by 4 inches, (57 mm **millimeters** by 102 mm **millimeters**), mounted in walls or ceilings, and where the cable is fastened within 8 inches, (2,032 mm **millimeters**), of the box measured along the sheath, and where the sheath extends through a cable knockout not less than ¼ inch, (6.4 mm **millimeters**), securing the cable to the box shall not be required. Multiple cable entries shall be permitted in a single cable knockout opening. [314.17(c) Exception amended]~~

~~E3908.9. Equipment fastened in place or connected by permanent wiring methods. Noncurrent-carrying metal parts of equipment, raceways, and other enclosures, where required to be grounded, shall be grounded by 1 of the following methods: [250.134]~~

~~(a) By any of the equipment grounding conductors permitted by Sections E3908.8 and E3908.8.3. [250.134(A)]~~

~~(b) By an equipment grounding conductor contained within the same raceway, cable, or cord, or otherwise run with the circuit conductors. Equipment grounding conductors shall be identified in accordance with Section E3407.2. [250.134(B) Exception]~~

~~E3908.9.1. Cord and plug-connected equipment. Non-current-carrying metal parts of the cord and plug-connected equipment, if grounded, shall be connected to an equipment grounding conductor by 1 of the methods in E3908.9.1.1 and E3908.9.1.2. [250.138]~~

~~E3908.9.1.1. By means of an equipment grounding conductor. By means of an equipment grounding conductor run with the power supply conductors in a cable assembly or flexible cord properly terminated in a grounding-type attachment plug with 1 fixed grounding contact. [250.138(A)]~~

~~Exception: The grounding contacting pole of grounding-type plug-in ground-fault circuit interrupters may be of the movable, self-restoring type on circuits operating at not over 150 volts between any 2 conductors or over 150 volts between any conductor and ground. [250.138(A) Exception]~~

~~E3908.9.1.2. By means of a separate flexible wire or strap. By means of a separate flexible wire or strap, insulated or bare, connected to an equipment grounding conductor, and protected as well as practicable against physical damage, where part of the equipment. [250.138(B)]~~

~~E3908.10. Methods of equipment grounding. Fixtures and equipment shall be considered grounded where mechanically connected to an equipment grounding conductor as specified in Sections E3908.8 and E3908.8.3. Wire-type equipment grounding conductors shall be sized in accordance with Section E3908.12.~~

R 408.30537c ~~Devices and luminaires. Rescinded.~~

~~–Rule 537c. Sections E4002.2, and E4002.16, are amended to read as follows:~~

~~–E4002.2. Grounding type. Receptacles installed on 15- and 20-ampere-rated branch circuits shall be of the grounding type and connected to an equipment grounding conductor.~~

~~–Exception: Replacement receptacles as permitted by Section E4002.16.~~

~~–E4002.16. Replacements. Replacement of receptacles shall comply with the following as applicable. [406.4(D) amended]~~

~~–(1) Grounding type receptacles. Where a grounding means exists in the receptacle enclosure or an equipment grounding conductor is installed grounding type receptacles shall be used and shall be connected to the equipment grounding conductor. [406.4(D)(1) amended]~~

~~–(2) Non grounding type receptacles. Where attachment to an equipment grounding conductor does not exist in the receptacle enclosure, the installation shall comply with 1 of the following: [406.4(D)(2) amended]~~

~~–(a) A non grounding type receptacle may be replaced with another non grounding type receptacle. [406.4(D)(2)(a)]~~

~~–(b) A non grounding type receptacle may be replaced with a ground fault circuit interrupter type of receptacle. These receptacles shall be marked “no equipment ground.” An equipment grounding conductor shall not be connected from the ground fault circuit interrupter type receptacle to any outlet supplied from the ground fault circuit interrupter receptacle. [406.4(D)(2)(b)]~~

~~–(c) A non grounding type receptacle may be replaced with a grounding type receptacle where supplied through a ground fault circuit interrupter. Grounding type receptacles supplied through the ground fault circuit interrupter shall be marked “GFCI protected” and “no equipment ground.” An equipment grounding conductor shall not be connected between the grounding type receptacles. [406.4(D)(2)(c)]~~

~~–(3) Ground fault circuit interrupters. Ground fault circuit interrupter protected receptacles shall be provided where replacements are made at receptacle outlets that are required to be so protected elsewhere in this code. [406.4(D)(3)]~~

~~–Exception: Where replacement of the receptacle type is impracticable, such as where the outlet box size will not permit the installation of the GFCI receptacle, the receptacle may be replaced with a new receptacle of the existing type, where GFCI protection is provided and the receptacle is marked “GFCI protected” and “no equipment ground” in accordance with E4002.16 (2)(a), (b), or (c). [406.4(D)(3) Exception]~~

R 408.30537d ~~Frames of ranges and clothes dryers. Rescinded.~~

~~–Rule 537d. Section E4101.8 of the code is added to read as follows:~~

~~–E4101.8. Frames of ranges and clothes dryers. Frames of electric ranges, wall mounted ovens, counter mounted cooking units, clothes dryers, and outlet or junction boxes that are part of the circuit for these appliances shall be connected to the equipment grounding conductor in the manner specified in E3908.9. [250.140 amended]~~

~~–Exception: For existing branch circuit installations only where an equipment grounding conductor is not present in the outlet or junction box, the frames of electric ranges, wall-mounted ovens, counter-mounted cooking units, clothes dryers, and outlet or junction boxes that are part of the circuit for these appliances may be connected to the grounded circuit conductor if all of the following conditions are met: [250.140 Exception]~~

- ~~1. The supply circuit is 120/240-volt single-phase, 3-wire connected system. [250.140 Exception (1)]~~
- ~~2. The grounded conductor is not smaller than 10 AWG copper or 8 AWG aluminum. [250.140 Exception (2)]~~
- ~~3. The grounded conductor is insulated, or the grounded conductor is uninsulated and part of a type SE service-entrance cable and the branch circuit originates at the service equipment. [250.140 Exception (3)]~~
- ~~4. Grounding contacts of the receptacles furnished as part of the equipment are bonded to the equipment. [250.140 Exception (4)]~~

R 408.30538 Combustible insulation. Rescinded.

~~–Rule 538. Section 302.13 of the code is amended to read as follows:~~

~~–302.13. Combustible insulation. Combustible insulation shall be separated a minimum of 3 inches (76 mm) from recessed lighting fixtures, fan motors, and other heat-producing devices.~~

~~–Exception: When heat-producing devices are listed for lesser clearances, combustible insulation complying with the listing requirements shall be separated in accordance with the conditions stipulated in the listing.~~

~~–Recessed lighting fixtures installed in the building thermal envelope shall be installed in accordance with the manufacturer's installation instructions.~~

R 408.30539a Automatic fire sprinkler systems. Rescinded.

~~–Rule 539a. Sections R313.1, P2902.5.4 and P2904.1 of the code are amended to read as follows:~~

~~–R313.1. Design and installation. Where installed, automatic residential fire sprinkler systems shall conform to the design and installation requirements of the national fire protection association (NFPA) standard 13D or P2904.1.~~

~~–P2902.5.4. Connections to automatic fire sprinkler systems. The potable water supply to automatic fire sprinkler systems shall be protected against backflow by a double check valve assembly or a reduced pressure principle backflow preventer.~~

~~–Exception: Isolation of the water distribution system is not required for deluge, preaction, or dry pipe system.~~

~~–P2904.1. General. Where installed, residential fire sprinkler systems, or portions thereof, shall be in accordance with NFPA 13D.~~

R 408.30540 Elevators and platform lifts. Rescinded

~~–Rule 540. Sections R321.1, R321.2, and R321.3 of the code are amended to read as follows:~~

~~–R321.1. Elevators. Where provided, passenger elevators, limited-use/limited-application elevators or private residence elevators shall comply with the Michigan elevator rules R 408.7001 to R 408.8695.~~

~~–R321.2. Platform lifts. Where provided, platform lifts shall comply with the Michigan elevator rules R 408.7001 to R 408.8695.~~

~~–R321.3. Accessibility. Elevators or platform lifts that are part of an accessible route required by chapter 11 of the Michigan building code, shall comply with ICC A117.1, as listed in chapter 44, and 1966 PA 1, MCL125.1354 to MCL 125.1356.~~

R 408.30541a Duct Installation.

Rule 541a. Section M1502.4.2 of the code is amended to read as follows:

M1502.4.2. Duct Installation. Dryer exhaust ducts shall be supported at 4 foot, (1,219 mm **millimeters**), intervals and secured in place. The insert end of the duct shall extend into the adjoining duct or fitting in the direction of airflow. Ducts shall not be joined with screws or similar fasteners that protrude into the inside of the duct.

R 408.30542 Floor register location.—**Rescinded.**

—Rule 542. Section M1601.4.10 is added to the code to read as follows:

—M1601.4.10. Floor register location. Floor registers located in room or spaces containing water closets shall be located a minimum of 3 feet (914 mm) from the water closet.

R 408.30544 Light, ventilation, and heating.

Rule 544. Section R303.5.2 of the code is amended to read as follows:

R303.5.2. Exhaust openings. Outside exhaust openings shall be located as not to create a nuisance. Exhaust openings shall not be directed onto walkways. Exhaust openings shall not terminate within 3 feet, **914.4 millimeters**, of a ventilated section in a soffit.

R 408.30544a Townhouses.—**Rescinded.**

—Rule 544a. Section R302.2 of the code is amended to read as follows:

—R302.2. Townhouses. Each townhouse shall be considered a separate building and shall be separated by a 2-hour fire-resistance-rated wall assembly tested in accordance with ASTM E 119 or UL 263 with exposure from both sides.

—Exception: Where the building is provided with an automatic fire sprinkler system installed in accordance with NFPA 13D or P2904.1, a common 1-hour fire-resistance-rated wall assembly tested in accordance with ASTM E 119 or UL 263, as listed in chapter 44, is permitted for townhouses if such walls do not contain plumbing or mechanical equipment, ducts, or vents in the cavity of the common wall. The wall shall be rated for fire exposure from both sides and shall extend to and be tight against exterior walls and the underside of the roof sheathing. Electrical installations shall be installed in accordance with chapters 34 to 43. Penetrations of electrical outlet boxes shall be in accordance with section R302.4.

R 408.30544b Exterior walls.

Rule 544b. Section R302.5.1 of the code is amended and table R302.1(1) is added to read as follows:

R302.5.1. Opening protection. Openings from a private garage directly into a room used for sleeping purposes shall not be permitted. Other openings between the garage and residence shall be equipped with solid wood doors not less than 1-3/8 inches, (35 ~~mm~~ **millimeters**), in thickness, solid or honeycomb-core steel doors not less than 1-3/8 inches, (35 ~~mm~~ **millimeters**), thick, or 20-minute fire-rated doors.

TABLE R302.1(1)
EXTERIOR WALLS

EXTERIOR WALL ELEMENT		MINIMUM FIRE-RESISTANCE RATING	MINIMUM FIRE SEPARATION DISTANCE
Walls	Fire-resistance rated	1 hour-tested in accordance with ASTM E 119 or UL 263 with exposure from both sides	< 5 feet
	Not fire-resistance rated	0 hours	≥ 5 feet
Projections	Not allowed ^a	NA	< 2 feet
	Fire-resistance rated	1 hour on the underside	≥ 2 feet to < 5 feet
	Not fire-resistance rated	0 hours	≥ 5 feet
Opening in walls	Not allowed	N/A	< 3 feet
	25% maximum of wall area	0 hours	3 feet
	Unlimited	0 hours	5 feet
Penetrations	All	Comply with Section R302.4	< 5 feet
		None required	5 feet

For SI: 1 foot = 304.8 mm-millimeters.

N/A = Not applicable

- a. except as allowed as per Section R302.1 exceptions 3 and 4

~~R 408.30545 Masonry veneer wall covering.~~**Rescinded.**

~~Rule 545. Figures R703.8, R703.8.2.1, and R703.8.2.2, of the code are amended to read as follows:~~

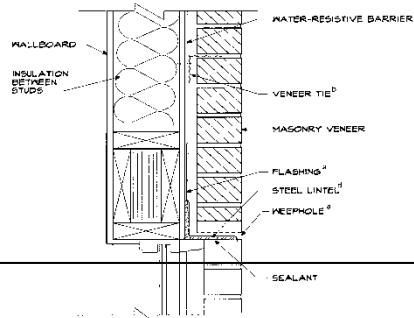

FIGURE R 703.8 - continued
MASONRY VENEER WALL DETAILS

- FOR 5/8" (1 INCH) x 25.4 mm
- a SEE SECTIONS R103.1.5, R103.1.6 AND R103.9
 - b SEE SECTIONS R103.2 AND R103.1.4
 - c SEE SECTIONS R103.1.4.2 AND R103.1.4.3
 - d SEE SECTION R103.1.3

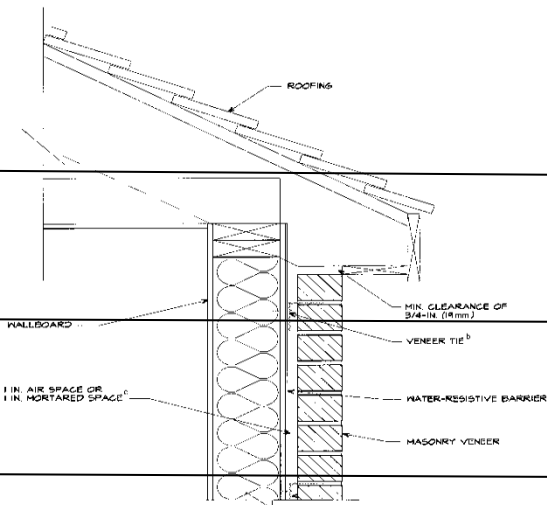
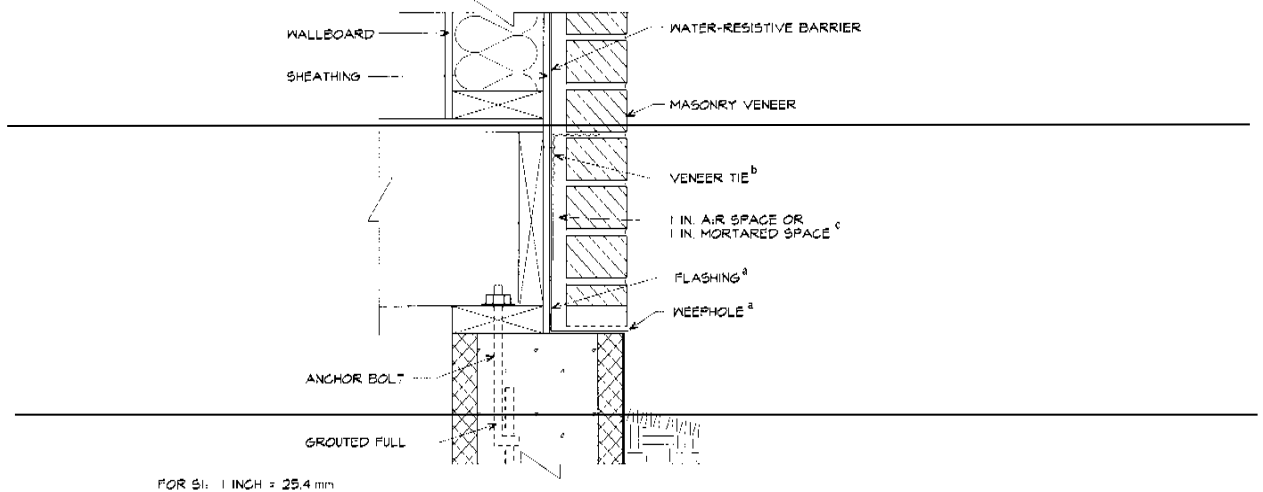

FIGURE R 703.8 - continued
MASONRY VENEER WALL DETAILS

- FOR 5/8" (1 INCH) x 25.4 mm
- a SEE SECTIONS R103.1.5, R103.1.6 AND R103.9
 - b SEE SECTIONS R103.2 AND R103.1.4
 - c SEE SECTIONS R103.1.4.2 AND R103.1.4.3
 - d SEE SECTION R103.1.3



FOR SI: 1 INCH = 25.4 mm

FIGURE R 703.8
MASONRY VENEER WALL DETAILS
(CONTINUED)

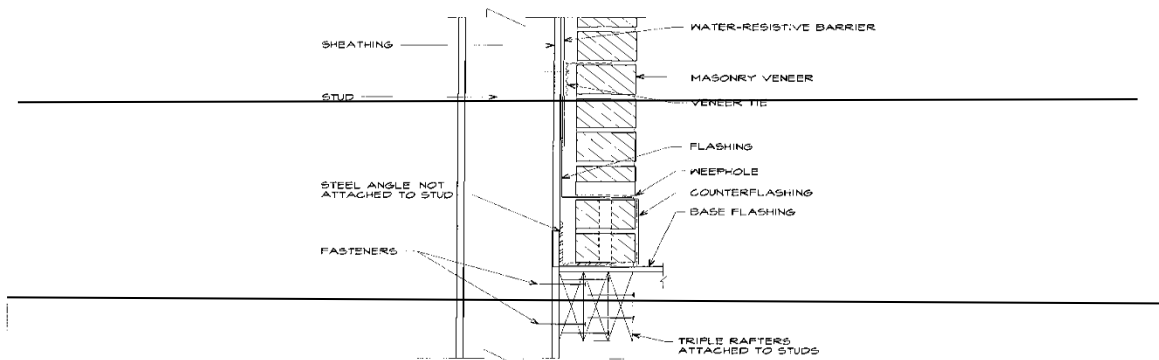

SUPPORT BY ROOF CONSTRUCTION
FIGURE R 703.8.2.2
EXTERIOR MASONRY VENEER SUPPORT BY ROOF CONSTRUCTION

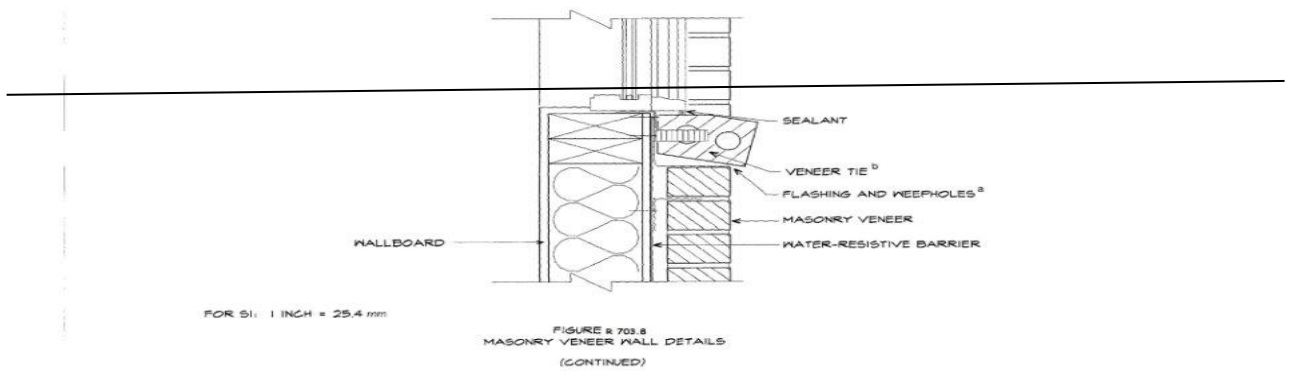
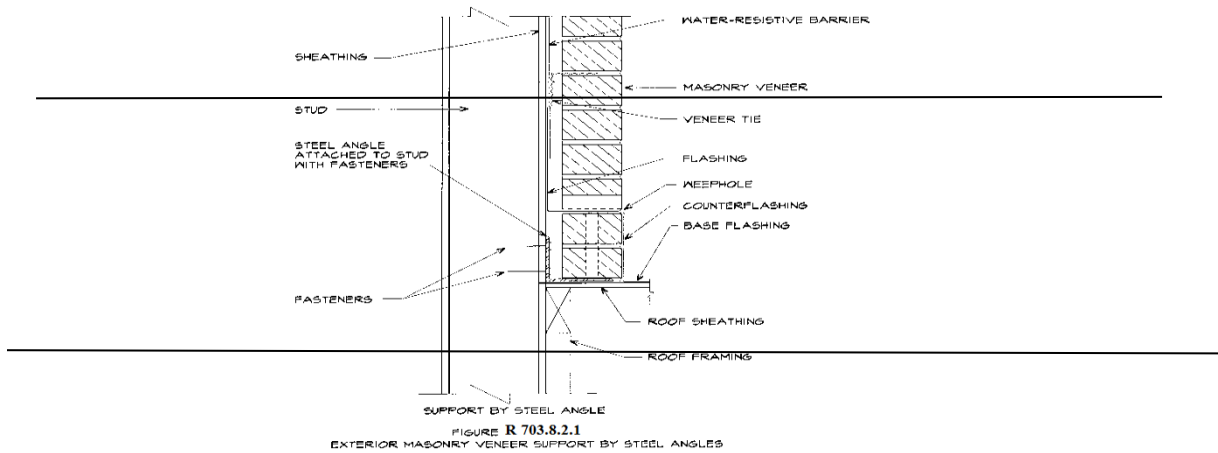

R 408.30545a ~~Masonry heater clearance. Rescinded.~~

~~Rule 545a. Section R1002.5 of the code is amended to read as follows:~~

~~R1002.5. Masonry heater clearance. Combustible materials shall not be placed within 36 inches (914 mm) of the outside surface of a masonry heater unless installed in accordance~~

with NFPA 211, and the required space between the heater and combustible material shall be fully vented to permit the free flow of air around all heater surfaces.

–Exceptions:

- 1. When the masonry heater wall is at least 8 inches (203 mm) thick of solid masonry and the wall of the heat exchange channels is at least 5 inches (127 mm) thick of solid masonry, combustible materials shall not be placed within 4 inches (102 mm) of the outside surface of a masonry heater. A clearance of at least 8 inches (203 mm) shall be provided between the gas-tight capping slab of the heater and a combustible ceiling.
- 2. Masonry heaters listed and labeled in accordance with UL 1482 may be installed in accordance with the listing specifications and the manufacturer's written instructions.

R 408.30547b Chimneys.–Rescinded.

–R547b. Sections R1003.9.1, R1005.4, Figure R1001.1, are amended and Figures R1003.9.1(1) and R1003.9.1(2) are added to read as follows:

–R1003.9.1. Chimney caps. Masonry chimneys shall have a concrete, metal, or stone cap sloped a minimum of 10 degrees to shed water, a drip edge or slot and shall be flashed in accordance with figure R1003.9.1(1). The joint space between the flue liner and the cap shall be filled with compressible filler and caulked with a suitable sealant to allow for expansion and contraction of the materials. All vertical joints in a chimney cap shall be caulked with a suitable sealant.

–The cap shall be a minimum of 2” (51 mm) thick at the outer edge and overhang the outer wall of the chimney by a minimum of 2” (51 mm). The drip slot shall be located not less than 1 1/2” (38 mm) from the outer surface of the chimney. A bond break shall be installed between the concrete cap and the chimney masonry.

–Metal caps shall lap down the chimney wall a minimum of 4” (102 mm) and be sealed with a suitable sealant.

–Joint sealants shall meet ASTM C 920, type S or M, grade NS, class 25 and be installed in accordance with the manufacturer's installation instructions.

–R1005.4. Factory built chimneys. Chimneys for use with factory built fireplaces shall comply with the requirements of UL 127. The metal chase cover shall be sloped a minimum of 10° to shed water. Metal chase cover shall lap down the chimney wall a minimum of 4” (102 mm) and be sealed with a suitable sealant. Exterior wall claddings shall be applied and flashed in accordance with Section R703 and manufacturer's installation instructions.

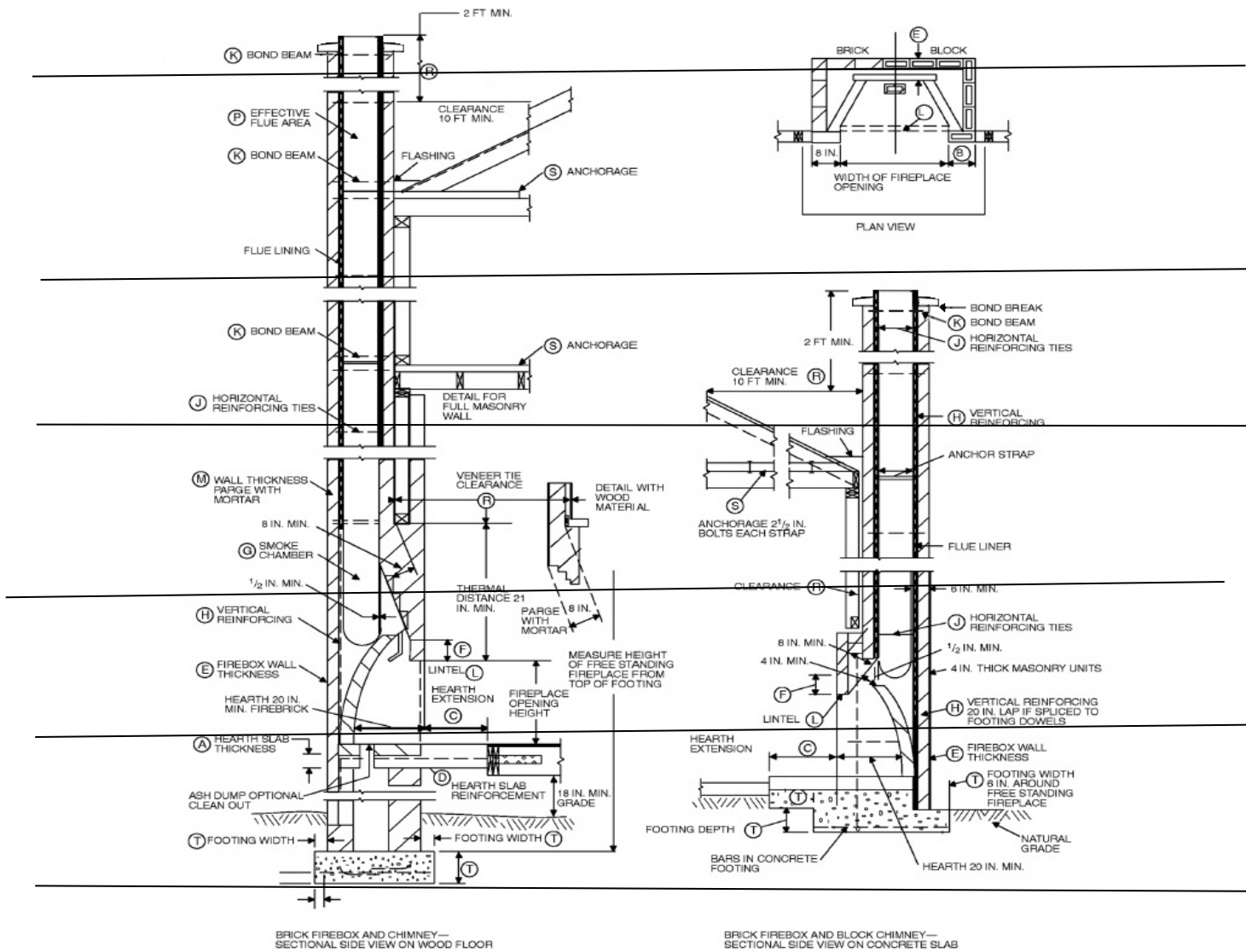

For SI: 1 inch = 25.4 mm, 1 foot = 304.8 mm.

Figure R1001.1
Fireplace and Chimney Details

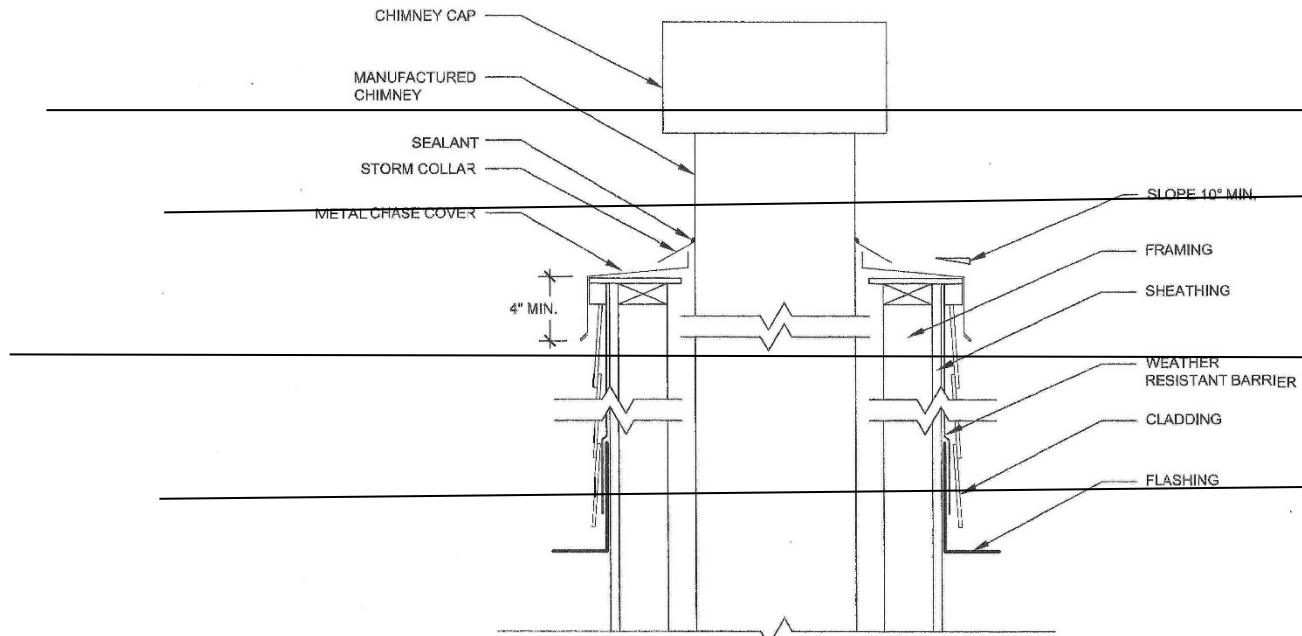

FIGURE R1003.9.1 (2)

R 408.30547c General—Rescinded.

~~Rule 547c. Sections N1101.3.1, N1101.7, N1101.10, N1101.12.3, N1101.16, tables N1101.10, and N1101.10.2(2) are amended and figure N1101.10a of the code is added to read as follows:~~

~~N1101.3.1 (R101.4.3). Additions, alterations, renovations, or repairs. Additions, alterations, renovations, or repairs to an existing building, building system, or portion thereof shall conform to the provisions of this code as they relate to new construction without requiring the unaltered portion(s) of the existing building or building system to comply with this code. Additions, alterations, renovations, or repairs shall not create an unsafe or hazardous condition or overload existing building systems. An addition shall be deemed to comply with this code if the addition alone complies or if the existing building and addition comply with this code as a single building.~~

~~Exception: The following are exempt provided the energy use of the building is not increased:~~

- ~~1. Storm windows installed over existing fenestration.~~
- ~~2. Glass only replacements in an existing sash and frame.~~
- ~~3. Existing ceiling, wall, or floor cavities exposed during construction provided that these cavities are filled with insulation.~~

- ~~–4. Construction where the existing roof, wall, or floor cavity is not exposed.~~
- ~~–5. Reroofing where the roof is part of the thermal envelope, and where neither the roof sheathing nor the roof insulation is exposed.~~
- ~~–6. Reroofing where the roof is not part of the thermal envelope.~~
- ~~–7. Replacement of existing doors that separate conditioned space from the exterior shall not require the installation of a vestibule or revolving door, provided, however, that an existing vestibule that separates a conditioned space from the exterior shall not be removed.~~
- ~~–8. Alterations that replace less than 50% of the luminaries in a space, provided that such alterations do not increase the installed interior lighting power.~~
- ~~–9. Alterations that replace only the bulb and ballast within the existing luminaries in a space provided that the alteration does not increase the installed interior lighting power.~~
- ~~–N1101.7 (R102.1.1). Above code programs. The state construction code commission may evaluate and approve a national, state, or local energy efficiency program to exceed the energy efficiency required by this code. Buildings approved in writing by such an energy efficiency program, such as ICC 700-2012 “silver” or energy star version 3 (rev. 07), shall be considered in compliance with this code. The requirements identified as “mandatory” in chapter 4 shall be met.~~
- ~~–N1101.10 (R301.1). Climate zones. Climate zones from figures 301.1, 301.1a or table 301.1 shall be used in determining the applicable requirements of this code.~~
- ~~–N1101.12.3. Fenestration product rating. U factors of fenestration products (windows, doors, and skylights) shall be determined in accordance with NFRC 100 by an accredited, independent laboratory, and labeled and certified by the manufacturer. Products lacking such a labeled U-factor shall be assigned a default U-factor from table N1101.12.3(1) or N1101.12.3(2).~~
- ~~–Exception: Computer simulations by independent NFRC certified laboratories or approval under section 21 of 1972 PA 230, MCL 125.1521 is considered in compliance with this section.~~
- ~~–N1101.16 (R401.3). Certificate (mandatory). A permanent certificate shall be posted on or in the electrical distribution panel, and shall meet all of the following:~~
 - ~~–(a) Be affixed or attached so it does not cover or obstruct the visibility of the circuit directory label, service disconnect label, or other required labels.~~
 - ~~–(b) Be completed by the builder or registered design professional.~~
 - ~~–(c) List the predominant R-values of insulation installed in or on ceiling/roof, walls, foundation (slab, basement wall, crawlspace wall and/or floor) and ducts outside conditioned spaces and U-factors for fenestration. If there is more than 1 value for each component, then the certificate shall list the value covering the largest area.~~
 - ~~–(d) List the types and efficiencies of heating, cooling, and service water heating equipment.~~
 - ~~–(e) If a gas-fired unvented room heater, electric furnace, or baseboard electric heater is installed in the residence, then the certificate shall list “gas-fired unvented room heater,” as appropriate. An efficiency shall not be listed for gas-fired unvented room heaters, electric furnaces, or electric baseboard heaters.~~

Climate Zones by County

Zones		
5A	6A	7
Allegan	Alcona	Baraga
Barry	Alger	Chippewa
Bay	Alpena	Gogebie
Berrien	Antrim	Houghton
Branch	Arenac	Iron
Calhoun	Benzie	Keweenaw
Cass	Charlevoix	Luce
Clinton	Cheboygan	Mackinac
Eaton	Clare	Ontonagon
Genesee	Crawford	Schoolcraft
Gratiot	Delta	
Hillsdale	Dickinson	
Ingham	Emmet	
Ionia	Gladwin	
Jackson	Grand Traverse	
Kalamazoo	Huron	
Kent	Iosco	
Lapeer	Isabella	
Lenawee	Kalkaska	
Livingston	Lake	
Macomb	Leelanau	
Midland	Manistee	
Monroe	Marquette	
Montcalm	Mason	
Muskegon	Mecosta	
Oakland	Menominee	
Ottawa	Missaukee	
Saginaw	Montmorency	
Shiawassee	Newaygo	
St. Clair	Oceana	
St. Joseph	Ogemaw	
Tuseola	Osceola	
Van Buren	Oscoda	
Washtenaw	Otsego	
Wayne	Presque Isle	
	Rosecommon	
	Sanilac	
	Wexford	

Key: A — Moist. Absence of moisture designation indicates moisture regime is irrelevant.

Table N1101.10.2(2)
Climate Zone Definitions

Zone Number	Thermal Criteria	
	IP Units	SI Units
5A	$5400 < \text{HDD}_{65^{\circ}\text{F}} \leq 7200$	$3000 < \text{HDD}_{18^{\circ}\text{C}} \leq 4000$
6A	$7200 < \text{HDD}_{65^{\circ}\text{F}} \leq 9000$	$4000 < \text{HDD}_{18^{\circ}\text{C}} \leq 5000$

7	$9000 < \text{HDD}_{65^{\circ}\text{F}} \leq 12600$	$5000 < \text{HDD}_{18^{\circ}\text{C}} \leq 7000$
For SI: $^{\circ}\text{C} = [(^{\circ}\text{F}) - 32] / 1.8$		

FIGURE N1101.10a
CLIMATE ZONES

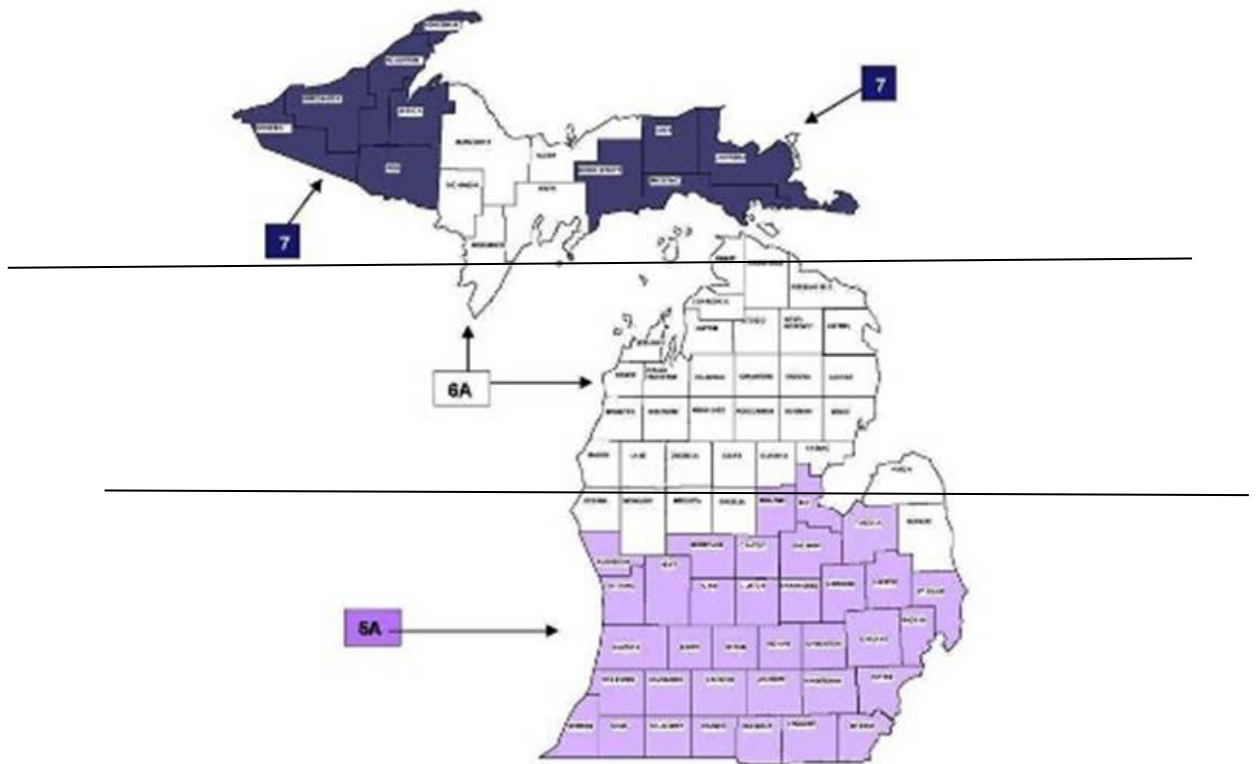

R 408.30547d Building thermal envelope. ~~Rescinded.~~

~~Rule 547d. Sections N1102.2.6, N1102.2.12, N1102.3.3, N1102.3.6, N1102.4, N1102.4.1.1, N1102.4.1.2, N1102.4.2, N1102.4.3, N1102.4.4, tables N1102.1.1, N1102.1.3, and N1102.4.1.1 of the code are amended to read as follows:~~

~~N1102.2.6 (R402.2.6). Steel frame ceilings, walls, and floors. Steel frame ceilings, walls, and floors shall meet the insulation requirements of table N1102.2.6 or shall meet the U-factor requirements in table N1102.1.3. The calculation of the U-factor for a steel frame envelope assembly shall use a series-parallel-path calculation method.~~

~~N1102.2.12 Thermally isolated sunroom insulation. The minimum ceiling insulation R-values shall be R-24 in zones 5 to 7. The minimum wall R-value shall be R-13 in all zones. New wall or walls separating a sunroom from conditioned space shall meet the building thermal envelope requirements.~~

~~N1102.3.3 (R402.3.3). Glazed fenestration exemption. Up to 15 square feet (1.4m²) of glazed fenestration per dwelling unit may be exempt from U-factor requirements in section N1102.1.1. This exemption shall not apply to the U-factor alternative approach in section N1102.1.1 and the total UA alternative in section N1102.1.4.~~

~~N1102.3.6 (R402.3.6). Replacement fenestration. Where some or all of an existing fenestration unit is replaced with a new fenestration product, including sash and glazing, the replacement fenestration unit shall meet the applicable requirements for U-factor in table N1102.1.3. Where some or all of an existing fenestration unit is replaced with a new fenestration product, including sash and glazing, the replacement fenestration unit shall meet the applicable requirements for U-factor in table N1102.1.1.~~

~~N1102.4 (R402.4). Air leakage. The building thermal envelope shall be constructed to limit air leakage in accordance with the requirements of sections N1102.4.1 through N1102.4.4.~~

~~N1102.4.1 (R402.4.1). Building thermal envelope. The building thermal envelope shall comply with sections N1102.4.1.1 and N1102.4.1.2.~~

~~N1102.4.1.1 (R402.4.1.1). Installation (mandatory). The components of the building thermal envelope as listed in table N1102.4.1.1 shall be installed in accordance with the manufacturer's instructions and the criteria listed in table N1102.4.1.1, as applicable to the method of construction. The sealing methods between dissimilar materials shall allow for differential expansion and contraction.~~

~~N1102.4.1.2 (R402.4.1.2). Testing (prescriptive). The building or dwelling unit shall be tested and verified as having an air leakage rate of not exceeding 4 air changes per hour. Testing shall be conducted with a blower door at a pressure of 0.2" w.g. (50 pascals). Where required by the code official, testing shall be conducted by a certified independent third party. Certification programs shall be approved by the state construction code commission. A written report of the results of the test shall be signed by the party conducting the test and provided to the code official. Testing shall be performed at any time after creation of all penetrations of the building thermal envelope.~~

~~During testing all of the following apply: _____~~

~~1. Exterior windows and doors, fireplace, and stove doors shall be closed, but not sealed, beyond the intended weather stripping or other infiltration control measures.~~

~~2. Dampers including exhaust, intake, makeup air, backdraft, and flue dampers shall be closed, but not sealed beyond intended infiltration control measures.~~

~~3. Interior doors, if installed at the time of the test, shall be open.~~

~~4. Exterior doors for continuous ventilation systems and heat recovery ventilators shall be closed and sealed.~~

- ~~–5. Heating and cooling systems, if installed at the time of the test, shall be turned off.~~
- ~~–6. Supply and return registers, if installed at the time of the test, shall be fully open.~~
- ~~–N1102.4.2 (R402.4.2). Fireplaces (mandatory). New wood-burning masonry fireplaces shall have tight fitting flue dampers and outdoor combustion air.~~
- ~~–N1102.4.3 (R402.4.3). Fenestration air leakage (mandatory). Windows, skylights, and sliding glass doors shall have an air infiltration rate of no more than 0.3 cfm per square foot (1.5 L/s/m²), and swinging doors no more than 0.5 cfm per square foot (2.6 L/s/m²), when tested according to NFRC 400 or AAMA/WDMA/CSA 101/I.S.2/A440 by an accredited, independent laboratory and listed and labeled by the manufacturer.~~
- ~~–Exception: Site built windows, skylights, and doors.~~
- ~~–N1102.4.4 (R402.4.4). Recessed lighting (mandatory). Recessed luminaires installed in the building thermal envelope shall be sealed to limit air leakage between conditioned and unconditioned spaces. All recessed luminaires shall be IC-rated and labeled as having an air leakage rate not more than 2.0 cfm (0.944 L/s) when tested in accordance with ASTM E 283 at a 1.57 psf (75 Pa) pressure differential. All recessed luminaires shall be sealed with a gasket or caulk between the housing and the interior wall or ceiling covering.~~

TABLE N1102.1.1 (R402.1.1)
INSULATION AND FENESTRATION REQUIREMENTS BY COMPONENT^a

Climate Zone	Fenestration U-Factor ^b	Skylight ^b U-Factor	Ceiling R-Value	Wood Frame-Wall R-Value	Mass Wall R-Value ^e	Floor R-Value	Basement ^c Wall R-Value	Slab ^d R-Value & Depth	Crawl Space ^c Wall R-Value
5A	0.32	0.55	38	20 or 13 + 5 ^f	13/17	30 ^e	10/13	10, 2 ft	15/19
6A	0.32	0.55	49	20 or 13 + 5 ^f	15/20	30 ^e	15/19	10, 4 ft	15/19
7	0.32	0.55	49	20 or 13 + 5 ^f	19/21	38 ^e	15/19	10, 4 ft	15/19

a. R-values are minimums. U-factors are maximums. When insulation is installed in a cavity which is less than the label or design thickness of the insulation, the installed R-value of the insulation shall not be less than the R-values specified in the table.

b. The fenestration U-factor column excludes skylights.

c. “15/19” means R-15 continuous insulation on the interior or exterior of the home or R-19 cavity insulation at the interior of the basement wall. “15/19” may be met with R-13 cavity insulation on the interior of the basement wall plus R-5 continuous insulation on the interior or exterior of the home. “10/13” means R-10 continuous insulation on the interior or exterior of the home or R-13 cavity insulation at the interior of the basement wall.

d. R-5 shall be added to the required slab edge R-values for heated slabs.

e. Or insulation sufficient to fill the framing cavity, R-19 minimum.

f. First value is cavity insulation, second is continuous insulation or insulated siding, so “13 + 5” means R-13 cavity insulation plus R-5 continuous insulation or insulated siding. If structural sheathing covers 40% or less of the exterior, continuous insulation R-value may be reduced by no more than R-3 in the locations where structural sheathing is used—to maintain a consistent total sheathing thickness.

g. The second R-value applies when more than 1/2 the insulation is on the interior of the mass wall.

TABLE N1102.1.3 (R402.1.3)
EQUIVALENT U FACTORS^a

Climate Zone	Fenestration U-Factor	Skylight U-Factor	Ceiling U-Factor	Frame Wall U-Factor	Mass Wall U-Factor ^b	Floor U-Factor	Basement Wall U-Factor	Crawl Space Wall U-Factor
5A	0.32	0.55	0.030	0.057	0.082	0.033	0.059	0.055
6A	0.32	0.55	0.026	0.057	0.060	0.033	0.050	0.055
7	0.32	0.55	0.026	0.057	0.057	0.028	0.050	0.055

- ~~a. Nonfenestration U factors shall be obtained from measurement, calculation, or an approved source.~~
- ~~b. When more than half the insulation is on the interior, the mass wall U factors shall be a maximum of 0.065 in zone 5 and marine 4, and 0.057 in zones 6 and 7.~~

TABLE N1102.4.1.1 (R402.4.1.1)
AIR BARRIER AND INSULATION INSTALLATION

COMPONENT	CRITERIA*
Air barrier and thermal barrier	<p>A continuous air barrier shall be installed in the building envelope. Exterior thermal envelope contains a continuous air barrier. Breaks or joints in the air barrier shall be sealed. Air permeable insulation shall not be used as a sealing material.</p>
Ceiling/attic	<p>The air barrier in any dropped ceiling/soffit shall be aligned with the insulation and any gaps in the air barrier sealed. Access openings, drop down stair, or knee wall doors to unconditioned attic spaces shall be sealed.</p>
Walls	<p>Corners and headers shall be insulated and the junction of the foundation and sill plate shall be sealed. The junction of the top plate and top of exterior walls shall be sealed. Exterior thermal envelope insulation for framed walls shall be installed in substantial contact and continuous alignment with the air barrier. Knee walls shall be sealed.</p>
Windows, skylights, and doors	<p>The space between window/door jambs and framing, and skylights and framing shall be sealed.</p>
Rim joists	<p>Rim joists shall be insulated and include the air barrier.</p>
Floors (including above garage and cantilevered floors)	<p>Insulation shall be installed to maintain permanent contact with underside of subfloor decking. The air barrier shall be installed at any exposed edge of insulation.</p>
Crawl space walls	<p>Where provided in lieu of floor insulation, insulation shall be permanently attached to the crawlspace walls. Exposed earth in unvented crawl spaces shall be covered with a class I vapor retarder with overlapping joints taped.</p>
Shafts, penetrations	<p>Duct shafts, utility penetrations, and flue shafts opening to exterior or unconditioned space shall be sealed.</p>
Narrow cavities	<p>Batts in narrow cavities shall be cut to fit, or narrow cavities shall be filled by insulation that on installation readily conforms to the available cavity space.</p>
Garage separation	<p>Air sealing shall be provided between the garage and conditioned spaces.</p>
Recessed lighting	<p>Recessed light fixtures installed in the building thermal envelope shall be air tight, IC rated, and sealed to the drywall.</p>

Plumbing and wiring	Batt insulation shall be cut neatly to fit around wiring and plumbing in exterior walls, or insulation that on installation readily conforms to available space shall extend behind piping and wiring.
Shower/tub on exterior wall	Exterior walls adjacent to showers and tubs shall be insulated and the air barrier installed separating them from the showers and tubs.
Electrical/phone box on exterior walls	The air barrier shall be installed behind electrical or communication boxes or air-sealed boxes shall be installed.
HVAC register boots	HVAC register boots that penetrate the building thermal envelope shall be sealed to the subfloor or drywall.
Fireplace	An air barrier shall be installed on fireplace walls.

a. In addition, inspection of log walls shall be in accordance with the provisions of ICC 400.

R 408.30547e ~~Simulated performance alternative.~~ **Rescinded.**

~~Rule 547e. Table N1105.5.2(1) [R405.5.2(1)] of the code is amended to read as follows:~~

TABLE N1105.5.2(1) [R405.5.2(1)]
SPECIFICATIONS FOR THE STANDARD REFERENCE AND PROPOSED DESIGNS

BUILDING COMPONENT	STANDARD REFERENCE DESIGN	PROPOSED DESIGN
Above-grade walls	Type: mass wall if proposed wall is mass; otherwise wood frame. Gross area: same as proposed U factor: from Table N1102.1.3 Solar absorptance = 0.75 Remittance = 0.90	As proposed As proposed As proposed As proposed As proposed
Basement and crawl space walls	Type: same as proposed Gross area: same as proposed U factor: from Table N1102.1.3, with insulation layer on interior side of walls.	As proposed As proposed As proposed
Above-grade floors	Type: wood frame Gross area: same as proposed U factor: from Table N1102.1.4	As proposed As proposed As proposed
Ceilings	Type: wood frame Gross area: same as proposed U factor: from Table N1102.1.4	As proposed As proposed As proposed

Roofs	Type: composition shingle on wood sheathing Gross area: same as proposed Solar absorptance = 0.75 Emittance = 0.90	As proposed As proposed As proposed As proposed
Attics	Type: vented with aperture = 1 ft ² per 300 ft ² ceiling area	As proposed
Foundations	Type: same as proposed foundation wall area above and below grade and soil. Characteristics: same as proposed	As proposed As proposed
Doors	Area: 40 ft ² Orientation: North U factor: same as fenestration from Table N1102.1.3.	As proposed As proposed As proposed
Glazing	Total ^b = - (a) The proposed glazing area: where proposed glazing area is less than 15% of the conditioned floor area. - (b) 15% of the conditioned floor area; where the proposed glazing area is 15% or more of the conditioned floor area. Orientation: equally distributed to four cardinal compass orientations (N, E, S & W). U factor: from Table N1102.1.4 SHGC: From Table N1102.1.2 except that for climates with no requirement (NR) SHGC = 0.40 shall be used. Interior shade fraction: 0.92 (0.21 x SHGC for the standard reference design) External shading: none	As proposed As proposed As proposed As proposed As proposed As proposed
Skylights	None	As proposed
Thermally isolated sunrooms	None	As proposed
Air exchange rate	Air leakage rate of 4 air changes per hour at a pressure of 0.2 inches w.g. (50 Pa). The mechanical ventilation rate shall be in addition to the air leakage rate and the same as in the proposed design, but no greater than $0.01 \times CFA + 7.5 \times (N_{br} + 1)$ where: CFA = conditioned floor area N _{br} = number of bedrooms Energy recovery shall not be assumed for mechanical ventilation.	The measured air exchange rate ^e . The mechanical ventilation rate ^d shall be in addition to the air leakage rate and shall be as proposed.

Internal gains	$IGain = 17,900 + 23.8 \times CFA + 4104 \times N_{br}$ (Btu/day per dwelling unit)	Same as standard reference design.
Internal mass	An internal mass for furniture and contents of 8 pounds per square foot of floor area.	Same as standard reference design, plus any additional mass specifically designed as a thermal storage element ^e but not integral to the building envelope or structure.
Structural mass	For masonry floor slabs, 80% of floor area covered by R-2 carpet and pad, and 20% of floor directly exposed to room air. For Masonry basement walls, as proposed, but with insulation required by Table R402.1.4 located on the interior side of the walls. For other walls, for ceilings, floors, and interior walls, wood frame construction.	As proposed As proposed As proposed
Heating systems ^{f,g}	As proposed for other than electric heating without a heat pump. Where the proposed design utilizes electric heating without a heat pump the standard reference design shall be an air source heat pump meeting the requirements of the Michigan energy code commercial provisions. Capacity: sized in accordance with Section N1103.7.	As proposed
Cooling systems ^{f,h}	As proposed Capacity: sized in accordance with Section N1103.7.	As proposed
Service water heating ^{f,g,h,i}	As proposed Use: same as proposed design	As proposed
Thermal distribution systems	Untested distribution systems: DSE = 0.88 Tested ducts: Leakage rate to outside conditioned space as specified Section N1103.3.2 Tested duct location: Unconditioned attic Tested duct insulation: in accordance with Section N1103.3.1	Untested distribution systems: DSE from Table N1105.5.2(2) Tested ducts: Tested leakage rate to outside conditioned space Duct location: As proposed Duct insulation: As proposed
Thermostat	Type: Manual, cooling temperature setpoint = 75°F; Heating temperature setpoint = 72°F	Same as standard reference

For SI: 1 square foot = 0.93 m², 1 British thermal unit = 1055 J, 1 pound per square foot = 4.88 kg/m², 1 gallon (U.S.) = 3.785 L, °C = (°F - 32)/1.8, 1 degree = 0.79 rad, 1 inch water gauge = 1250 Pa.

a. Glazing shall be defined as sunlight transmitting fenestration, including the area of sash, curbing, or other framing elements, that enclose conditioned space. Glazing includes the area of sunlight transmitting fenestration assemblies in walls bounding conditioned basements. For doors where the sunlight transmitting opening is less than 50% of the door area, the glazing area is the sunlight transmitting opening area. For all other doors, the glazing area is the rough frame opening area for the door including the door and the frame.

b. For residences with conditioned basements, R-2 and R-4 residences and townhouses, the following formula shall be used to determine glazing area:

$$AF = A_s \times FA \times F$$

where: ———

AF = Total glazing area.

A_s = Standard reference design total glazing area.

FA = (Above grade thermal boundary gross wall area)/(above grade boundary wall area + 0.5 x below grade boundary wall area).

F = (Above grade thermal boundary wall area)/(above grade thermal boundary wall area + common wall area) or 0.56, whichever is greater.

and where:

Thermal boundary wall is any wall that separates conditioned space from unconditioned space or ambient conditions.

Above grade thermal boundary wall is any thermal boundary wall component not in contact with soil.

Below grade boundary wall is any thermal boundary wall in soil contact.

Common wall area is the area of walls shared with an adjoining dwelling unit.

L and CFA are in the same units.

e. Where required by the code official, testing shall be conducted by a certified independent third party. Hourly calculations as specified in the ASHRAE handbook of fundamentals, or the equivalent shall be used to determine the energy loads resulting from infiltration.

d. The combined air exchange rate for infiltration and mechanical ventilation shall be determined in accordance with equation 43 of 2001 ASHRAE handbook of fundamentals, page 26.24 and the “whole house ventilation” provisions of 2001 ASHRAE handbook of fundamentals, page 26.19 for intermittent mechanical ventilation.

e. Thermal storage element shall mean a component not part of the floors, walls, or ceilings that is part of a passive solar system, and that provides thermal storage such as enclosed water columns, rock beds, or phase change containers. A thermal storage element must be in the same room as fenestration that faces within 15 degrees (0.26 rad) of true south, or must be connected to such a room with pipes or ducts that allow the element to be actively charged.

f. For a proposed design with multiple heating, cooling, or water heating systems using different fuel types, the applicable standard reference design system capacities and fuel types shall be weighted in accordance with their respective loads as calculated by accepted engineering practice for each equipment and fuel type present.

g. For a proposed design without a proposed heating system, a heating system with the prevailing federal minimum efficiency shall be assumed for both the standard reference and proposed design.

h. For a proposed design home without a proposed cooling system, an electric air conditioner with the prevailing federal minimum efficiency shall be assumed for both the standard reference design and the proposed design.

~~i. For a proposed design with a non-storage type water heater, a 40-gallon storage type water heater with the prevailing federal minimum energy factor for the same fuel as the predominant heating fuel type shall be assumed. For the case of a proposed design without a proposed water heater, a 40-gallon storage type water heater with the prevailing federal minimum efficiency for the same fuel as the predominant heating fuel type shall be assumed for both the proposed design and standard reference design.~~

R 408.30547f ~~Systems. Rescinded.~~

~~Rule 547e. Sections N1103.2.1, N1103.2.2, and N1103.4.2 of the code are amended to read as follows:~~

~~N1103.2.1. Insulation (prescriptive). All portions of the air distribution system shall be installed in accordance with Section M1601 and be insulated to an installed R-6 when system components are located within the building but outside the conditioned space, and R-8 when located outside to the building thermal envelope. When located within a building envelope assembly, at least R-8 shall be applied between the duct and that portion of the assembly farthest from conditioned space.~~

~~Exception: Portions of the air distribution system within appliances or equipment.~~

~~N1103.2.2. Sealing (mandatory). Ducts, air handlers, and filter boxes shall be sealed. Joints and seams shall comply with either the international mechanical code or international residential code, as applicable.~~

~~Exceptions:~~

~~1. Air impermeable spray foam products may be applied without additional joint seals.~~

~~2. Where a duct connection is made that is partially inaccessible, 3 screws or rivets shall be equally spaced on the exposed portion of the joint so as to prevent a hinge effect.~~

~~3. Continuously welded and locking type longitudinal joints and seams in ducts operating at static pressures less than 2 inches (51 mm) of water column (500 Pa) pressure classification shall not require additional closure systems.~~

~~Duct tightness shall be verified by either of the following:~~

~~1. Postconstruction test: Total leakage to the outside of a conditioned space or total leakage shall be less than or equal to 4 cfm (113.3 L/min) per 100 square feet (9.29 m²) of conditioned floor area when tested at a pressure differential of 0.1 inches (2.54 mm) w. g. (25 Pa) across the entire system, including the manufacturer's air handler enclosure. All register boots shall be taped or otherwise sealed during the test.~~

~~2. Rough in test: Total leakage shall be less than or equal to 4 cfm (113.3 L/min) per 100 square feet (9.29 m²) of conditioned floor area when tested at a pressure differential of 0.1 inches (2.54 mm) w.g. (25 Pa) across the system, including the manufacturer's air handler enclosure. All registers shall be taped or otherwise sealed during the test. If the air handler is not installed at the time of the test, total leakage shall be less than or equal to 3 cfm (85 L/min) per 100 square feet (9.29 m²) of conditioned floor area.~~

~~Exception: The total leakage test is not required for ducts and air handlers located entirely within the building thermal envelope.~~

~~N1103.4.2. Hot water pipe insulation (prescriptive). Insulation for hot water pipe with a minimum thermal resistance (R-value) of R-3 shall be applied to the following:~~

~~1. Piping larger than 3/4 inch nominal diameter.~~

~~2. Piping serving more than 1 dwelling unit.~~

~~3. Piping located outside the conditioned space.~~

~~4. Piping from the water heater to a distribution manifold.~~

~~5. Piping located under a floor slab.~~

~~6. Buried piping.~~

~~7. Supply and return piping in recirculation systems other than demand recirculation systems.~~

R 408.30547g ~~Energy rating index compliance alternative. Rescinded.~~

~~Rule 547f. Sections N1106.1, N1106.2, N1106.3, N1106.3.1, N1106.4, N1106.5, N1106.6, N1106.6.1, N1106.6.2, N1106.6.3, N1106.7, N1106.7.1, N1106.7.2, N1106.7.3, and table N1106.4 of the code are added to read as follows:~~

~~N1106.1 (R406.1). Scope. This section establishes criteria for compliance using an energy rating index (ERI) analysis.~~

~~N1106.2 (R406.2). Mandatory requirements. Compliance with this section requires that the mandatory provisions identified in sections N1101.2 and N1103.4.2 be met. The building thermal envelope shall be greater than or equal to levels of efficiency and solar heat gain coefficient in table 402.1.2 or 402.1.4 of the 2009 international energy conservation code.~~

~~Exception: Supply and return ducts not completely inside the building thermal envelope shall be insulated to a minimum of R-6.~~

~~N1106.3 (R406.3). Energy rating index. The energy rating index (ERI) shall be a numerical integer value that is based on a linear scale constructed such that the ERI reference design has an index value of 100 and a residential building that uses no net purchased energy has an index value of 0. Each integer value on the scale shall represent a 1% change in the total energy use of the rated design relative to the total energy use of the ERI reference design. The ERI shall consider all energy used in the residential building.~~

~~N1106.3.1 (R406.3.1). ERI reference design. The ERI reference design shall be configured such that it meets the minimum requirements of the 2006 international energy conservation code prescriptive requirements.~~

~~The proposed residential building shall be shown to have an annual total normalized modified load less than or equal to the annual total loads of the ERI reference design.~~

~~N1106.4 (R406.4). ERI-based compliance. Compliance based on an ERI analysis requires that the rated design be shown to have an ERI less than or equal to the appropriate value listed in table N1106.4 when compared to the ERI reference design.~~

~~N1106.5 (R406.5). Verification by approved agency. Verification of compliance with section N1106 shall be completed by an approved third party.~~

~~N1106.6 (R406.6). Documentation. Documentation of the software used to determine the ERI and the parameters for the residential building shall be in accordance with sections N1106.6.1 through N1106.6.3.~~

~~N1106.6.1 (R406.6.1). Compliance software tools. Documentation verifying that the methods and accuracy of the compliance software tools conform to the provisions of this section shall be provided to the code official.~~

~~N1106.6.2 (R406.6.2). Compliance report. Compliance software tools shall generate a report that documents that the ERI of the rated design complies with sections N1106.3 and N1106.4. The compliance documentation shall include all of the following information:~~

~~1. Address or other identification of the residential building.~~

~~2. An inspection checklist documenting the building component characteristics of the rated design. The inspection checklist shall show results for both the ERI reference design and the rated design, and shall document all inputs entered by the user necessary to reproduce the results.~~

~~3. Name of individual completing the compliance report.~~

~~4. Name and version of the compliance software tool.~~

~~Exception: Multiple orientations. Where an otherwise identical building model is offered in multiple orientations, compliance for any orientation shall be permitted by documenting that the building meets the performance requirements in each of the 4 (north, east, south and west) cardinal orientations.~~

~~N1106.6.3 (R406.6.3). Additional documentation. The code official may require the following documents:~~

~~1. Documentation of the building component characteristics of the ERI reference design.~~
~~2. A certification signed by the builder providing the building component characteristics of the rated design.~~

~~3. Documentation of the actual values used in the software calculations for the rated design.~~
~~N1106.7 (R406.7). Calculation software tools. Calculation software, where used, shall be in accordance with sections N1106.7.1 through N1106.7.3.~~

~~N1106.7.1 (R406.7.1). Minimum capabilities. Calculation procedures used to comply with this section shall be software tools capable of calculating the ERI as described in section N1106.3, and shall include the following capabilities:~~

~~1. Computer generation of the ERI reference design using only the input for the rated design.~~
~~The calculation procedure shall not allow the user to directly modify the building component characteristics of the ERI reference design.~~

~~2. Calculation of whole building, as single zone, sizing for the heating and cooling equipment in the ERI reference design residence in accordance with section N1103.7.~~

~~3. Calculations that account for the effects of indoor and outdoor temperatures and part load ratios on the performance of heating, ventilating, and air conditioning equipment based on climate and equipment sizing.~~

~~4. Printed code official inspection checklist listing each of the rated design component characteristics determined by the analysis to provide compliance, along with their respective performance ratings.~~

~~N1106.7.2 (R406.7.2). Specific approval. Performance analysis tools meeting the applicable sections of section N1106 shall be approved. Tools are permitted to be approved based on meeting a specified threshold for a jurisdiction. The code official shall approve tools for a specified application or limited scope.~~

~~N1106.7 (R406.7.3). Input values. When calculations require input values not specified by sections N1102, N1103, N1104, and N1105, those input values shall be taken from an approved source.~~

Table N1106.4 (R406.4)
 Maximum Energy Rating Index

Climate Zone	Energy Rating Index
1	52
2	52
3	51
4	54
5	55
6	54
7	53
8	53